

**ИСО 9001**



**FIRE ALARM AND EXTINGUISHING  
CONTROL UNIT**

**S2000-ASPT**

Engineer's and User's Manual

## CONTENTS

1	General.....	4
2	Specifications.....	5
3	Standard Delivery .....	36
4	Marking.....	37
5	Packing .....	37
6	Operating Instructions .....	37
7	Safety Precautions .....	37
8	Design of the S2000-ASPT .....	38
9	Installation Procedure .....	39
10	Preparation for Work .....	40
11	Performance.....	42
12	Troubleshooting.....	43
13	Maintenance.....	44
14	Storage .....	44
15	Transportation.....	44
16	Certificates.....	45
	Appendix A <i>Design of the S2000-ASPT</i> .....	46
	Appendix B <i>S2000-ASPT Connection Diagram</i> .....	48
	Appendix C <i>Schematics for Wiring Detectors into Alarm Loops</i> .....	49
	Appendix D <i>Connecting Devices for Operation in a Fixed Fire Extinguishing System</i> .....	51
	Appendix E <i>Wiring the S2000-ASPT for Testing</i> .....	53
	Appendix F <i>Calculating the Battery Operation Time</i> .....	54
	Appendix G <i>Personnel Action Plan in Case of Activation of the Fixed Fire Extinguishing System</i> .....	56

### WARNING

To modify the configuration parameters of the unit please use  
**UPROG.EXE software utility of version 4.1.0.52** and higher.

This Engineer's and User's Manual is intended to help for studying operability principles and maintenance of the S2000-ASPT Fire Alarm and Extinguishing Control Unit of version **3.51**.

**Please read the instructions completely before connecting, operating, adjusting or maintaining this product.**

The following terms are used throughout the Manual:

**Alarm Loop:** All the detectors and wires connected to an input of the S2000-ASPT, an initiating device circuit.

**Input:** An actual input of the S2000-ASPT which an alarm loop can be connected to.

## 1 General

1.1 S2000-ASPT Fire Alarm and Extinguishing Control Unit (hereinafter referred to as the S2000-ASPT or the unit) is designed to operate as part of a fixed gaseous, dry chemical, or aerosol fire suppression system. The S2000-ASPT operates only within an Orion system under a network controller (an S2000M panel) in cooperation with an S2000-PT control and indicator module.

1.2 The main functions of the S2000-ASPT are to:

- Protect a single discharge area <sup>1)</sup>;
- Control a fixed gaseous, dry chemical, or aerosol fire suppression system in automatic mode and remotely;
  - Receive and handle signals from automatic detectors and call points both passive and active (powered via its alarm loops) and four-wire fire detectors with normally closed or normally open internal contacts;
  - Control light and sound notification appliances. These notification appliances are not the appliances of Type 1 and Type 2 in Russian standard classification;
  - Control auxiliary equipment (switch ventilation systems off etc.);
  - Receive commands from and send messages to the network controller (S2000M panel) over the RS-485 interface;
  - Monitor for operability of release circuits and notification appliance circuits;
  - Monitor for operability of the fixed fire suppression installation;
  - Receive signals from:
    - Door position sensors;
    - Pressure detectors;
    - Mass or Pressure fault outputs of fire-fighting equipment;
    - S2000-KPB release units;
    - Manual release stations;
  - Transmit Fire Alarm and Fault messages to a fire brigade.

The S2000-ASPT can be used in cooperation with S2000-KPB units to increase the number of release circuits.

1.3 The S2000-ASPT can operate either standalone or under control of an Orion network controller in a fire alarm and fire protection system.

---

<sup>1)</sup> A discharge area means an area where an extinguishing agent is to be released simultaneously or within a short-duration time.

1.4 The S2000-ASPT is powered by:

- The main power supply: mains utility power 220 V, 50 Hz;
- The backup power supply: two 12 V backup batteries assembled in series.

**WARNING: DO NOT operate the S2000-ASPT without connected backup batteries**

1.5 The unit is intended for round-the-clock operation.

1.6 The unit is not designed to be used in aggressive/dust media or in ex-hazardous premises.

1.7 The ingress protection rating of the S2000-ASPT is IP30 (IEC 529-89).

1.8 According to the resistance to mechanical shocks the unit corresponds to the LX group in accordance with Russian Standard ГOCT P 52931-2008 – vibration loads in the frequency range from 1 to 35 Hz at maximum acceleration of  $4.9 \text{ m/s}^2$  (0.5 g).

1.9 An electric strength of insulation of current-carrying parts of the unit is at least 1500 V (50 Hz) between the circuits coupled with the mains utility power 220 V and another circuits not coupled with this one.

1.10 An electrical resistance of insulation between the circuits mentioned above is at least 20 megaohms (in normal conditions in accordance with Russian Standard ГOCT P 52931-2008).

## 2 Specifications

2.1 The number of monitored inputs.

2.1.1 The number of discharge areas is 1.

2.1.2 The number of alarm loops is 3.

2.2 The number of switched circuits per a single discharge area is 8.

2.2.1 The number of circuits for actuation of the fire suppression system:

- «R»: The release circuit (without S2000-KPB units) – 1;
- In cooperation with S2000-KPB units – up to 97.

2.2.2 The number of outputs to control light alarms is 3:

- VA1: EXIT light signs;
- VA2: KEEP OUT light signs;
- VA3: AUTOMATICS OFF light signs.

2.2.3 The number of outputs to control sound alarms is 1:

- SA: Siren output.

2.2.4 The number of outputs to control technological equipment is 1:

- NO-NC-C output.

2.2.5 The number of signal outputs is 2:

- FR (Fire Alarm);
- FLT (Fault).

2.3 The number of monitored inputs is 9:

- Monitoring of fire alarm loops (LOOP 1, LOOP 2, LOOP 3) – 3;
- Monitoring of door position sensor circuit (DOOR CIRCUIT) – 1;
- The input for the manual release station circuit (CALL POINTS) – 1;
- The input for the pressure detector circuit (DISCHARGE) – 1;
- The input to monitor troubles of fire protection equipment (EXTERNAL FAULT) – 1;
- RS-485 interface ports («A1-B1», «A2-B2») – 2.

2.4 The number of outputs to a fire brigade is 2:

- «Fire Alarm» (FR);
- «Fault» (FLT).

2.5 The number of outputs to supply power to 24 V external devices is 1:

- 24V.

2.6 The number of event types:

- NO PULSE RELESE;
- ARMED (An alarm loop has just been armed);
- DISARMED (An alarm loop has just been disarmed);

- OUTPUT DISABLED (The output is neither monitored nor controlled);
- OUTPUT ENABLED (The output is monitored and can be controlled);
- INPUT COM LOST (Loss of communication with the S20000-KPB);
- INPUT COM RESTORED (Communication with the S2000-KPB is restored);
- OUTPUT COM LOST (Loss of communication with the S20000-KPB);
- OUTPUT COM RESTORED (Communication with the S2000-KPB is restored);
- AUXILIARY LOOP ALARM;
- AUXILIARY LOOP ALARM 2;
- AUXILIARY LOOP RECOVERY;
- ARMING FAILED (The input has been activated during arming);
- FIRE EQP TROUBLE;
- FIRE TROUBLE RESTORED;
- FIRE SIGNAL;
- FIRE PREALARM;
- FIRE ALARM;
- RELEASE;
- PREDISCHARGE DELAY (Counting of the pre-discharge delay is started/continued);
- PREDISCHARGE TIME HOLD (Counting of the pre-discharge delay has been stopped);
- IMMEDIATE ACTIVATION;
- RELEASE INHIBITED;
- CANCEL RELEASE;
- LOOP TRBL OPEN (Open-circuit failure in the alarm loop);
- LOOP TRBL SHORT (Short circuit failure in the alarm loop);
- RELAY TRBL SHORT (Short-circuit failure of relay output load circuit);
- RELAY TRBL OPEN (Open-circuit failure of relay output load circuit);
- RELAY RESTORED (Relay output load circuit has been restored);
- AC POWER FAILED;
- AC POWER RESTORED;
- POWER FAILED;
- POWER RESTORED;
- BATTERY FAILED;
- BATTERY RESTORED;
- TAMPER ALARM;
- TAMPER RESTORED;
- DEVICE RESET;
- MANUAL TESTING;
- ALARM RESET;
- GAS PRESS SIGNAL;
- INT ZONE RESTORED;
- EXTINGUISHING;
- RELEASE FAULT;
- EX MODE AUTO;
- EX MODE MANUAL;
- LOW LEVEL;
- TOO LOW LEVEL;
- HIGH LEVEL;
- TOO HIGH LEVEL;
- NORMAL LEVEL;
- PUMP ON;
- PUMP OFF;
- SELF-TEST ERROR.

2.7 Destination and parameters of outputs to control external devices are shown in Table 2.1.

**Table 2.1** The Purpose and Parameters of the Outputs to Control External Devices

Output	Type	Parameters	Purpose
VA1	A group of normally open relay contacts with monitoring load circuits for open and short failures	<i>Only when batteries are connected</i> Voltage (24±2) V, 1 A (up to 2 A within 2 s); Circuit control current 1.5 mA	To connect a visual alarm 1 (EXIT sign)
VA2			To connect a visual alarm 2 (KEEP OUT sign)
VA3			To connect a visual alarm 3 (AUTOMATICS OFF sign)
SA			To connect a sound alarm (siren)
R			Release circuit – the output for connecting circuits actuating the fire suppression system (ignition cylinders, magnetic valves and so on)
FR	Normally open solid state relay contacts	Maximum switched voltage 100 V/0.1 A (dc)	To transmit Fire Alarm messages to a fire brigade
FLT			To transmit Fault messages to a fire brigade
24V	DC power supply	Voltage (24±2) V (see App.E)	To supply external devices with power of 24 V voltage and 200 mA current max
NO-NC-C	Changeover relay contacts	Maximum switched voltage 28 V dc /2 A 128 V ac /0.5 A	To control technological equipment: to shut off ventilation, air conditioning, air heating, to close air lock, fire damper and so on NO-C – normally open contacts; NC-C – normally closed contacts

2.7.1 The S2000-ASPT transmits a Fault message by opening the contacts of the FLT signal relay.

A Fault message is generated when any trouble listed below has detected:

- A short or open failure in one of the unit's alarm loops, the door circuit sensor, the notification appliance circuits, in the release circuit, in the call point circuit, in the pressure detector circuit, the fire equipment fault circuit;
- An overcurrent of VA or/and SA outputs during powering on;
- A failure of mains or backup power supply;
- A tampering of the S2000-ASPT;
- Input or output having disabled;
- Receiving a fault message from any connected S2000-KPB;
- Loss of communication with any connected S2000-KPB.

2.7.2 The S2000-ASPT transmits a Fire Alarm message to the fire brigade by closing the contacts of the alarm relay if:

- The S2000-ASPT has entered Fire Alarm mode;
- The fixed fire suppression system has been actuated remotely.

2.7.3 The relay NO-NC-C can be controlled locally (by control cause-effect programs in dependence to the states of the inputs and outputs of the S2000-ASPT) or centrally by network controller commands (see Section 2.15.2).

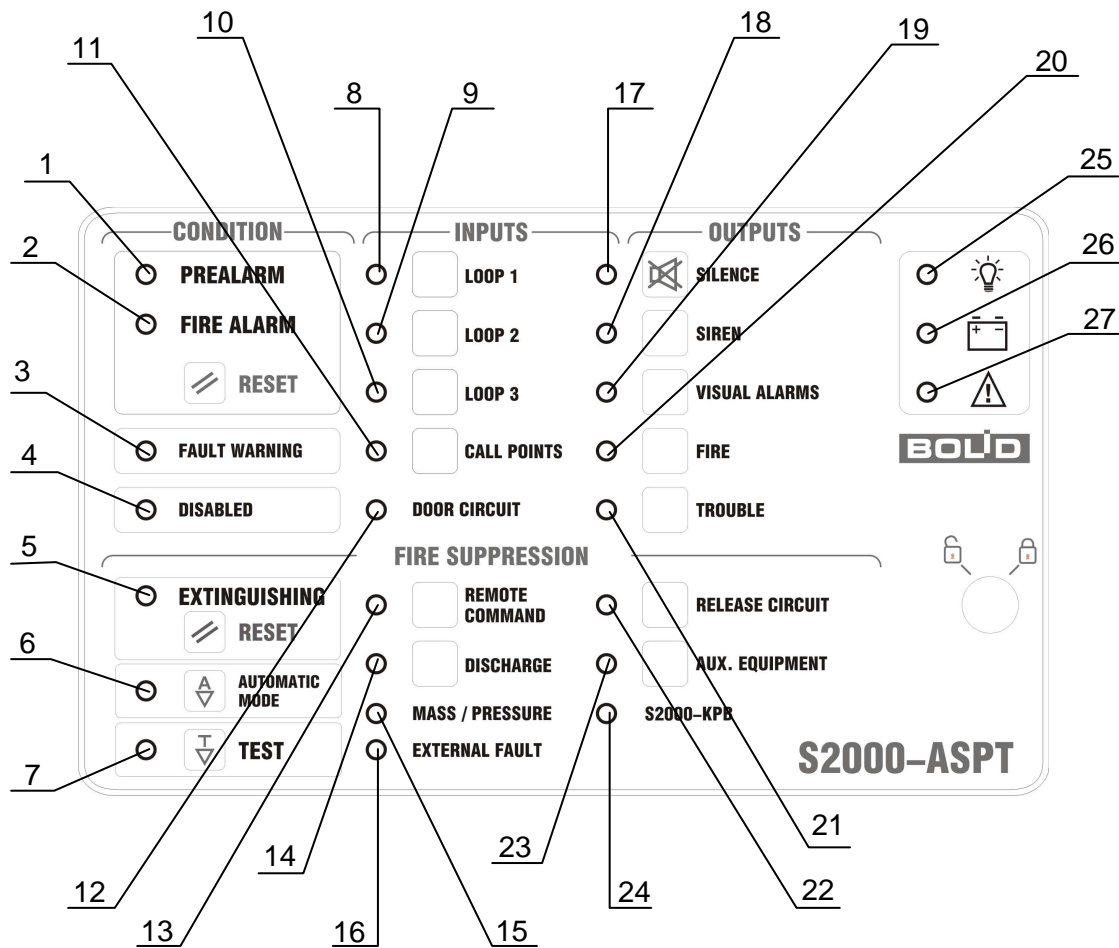

2.8 There are 27 LED indicators on the faceplate of the S2000-ASPT. The indicators are shown in Table 2.1. Their destination and performance are described in Table 2.2.



**Figure 2.1** Arrangement of Light Indicators

**Table 2.2** S2000-ASPT Indicators

No.	Indicator	Color	Destination
1	PREALARM	Red	Fire Prealarm mode indicator
2	FIRE ALARM	Red	Fire Alarm mode indicator
3	FAULT WARNING	Amber	Fault mode indicator
4	DISABLED	Amber	Disabled mode indicator
5	EXTINGUISHING	Red	Extinguishing mode indicator
6	AUTOMATIC MODE	Amber	Automatic release mode indicator, VA3 light sign
7	TEST	Amber	Indication Test, Self-Diagnostic mode indicator
8	LOOP 1	Red	Fire Signal, Fire Prealarm, Fire Alarm indication
9	LOOP 2	Amber	Arming Failed, Fault, Disable indication
10	LOOP 3		
11	CALL POINTS	Red	Fire Alarm indication
		Amber	Arming Failed, Fault, Disabled indication
12	DOOR CIRCUIT	Amber	Actuation, Fault indication
13	REMOTE COMMAND	Red	Fire Alarm indication
		Amber	Disabled condition indication

No.	Indicator	Color	Destination
14	DISCHARGE	Red	Extinguishing, No Pulse Release indication
		Amber	Fault, Disabled condition indication
15	MASS/PRESSURE	Amber	Actuation of inputs of the S2000-KPB units
16	EXTERNAL FAULT	Amber	Actuation, Fault condition indication
17	SILENCE	Amber	Indication of having the internal sounder silenced
18	SIREN	Red	Indication of switching the external sounder on
		Amber	Fault or Disabled conditions of the external sounder
19	VISUAL ALARMS*	Red	Indicates switching VA1, VA2 on
		Amber	Indicates Fault and Disabled conditions of VA1, VA2, VA3
20	FIRE	Red	Indication of sending a Fire Alarm signal to the fire brigade
		Amber	Disabled mode indication
21	FAULT	Amber	Indicates sending a Fault signal to the fire brigade and Disabled conditions
22	RELEASE CIRCUIT	Red	Indication of actuation of the release circuit
		Amber	Indication of the Fault and Disabled modes of the release circuit
23	AUX.EQUIPMENT	Red	Indicates the relay's being switched on
		Amber	Indicates the Disabled mode
24	S2000-KPB	Amber	Indicates a fault or loss of communication with one of the connected S2000-KPB
25	 Power	Green	Indicates conditions of the mains power
26	 On Batteries	Green**	Indicates conditions of the backup power
27	 Device Failure	Amber	Indicates unit's having entered the Device Failure mode when the S2000-ASPT cannot performs its functions

\* – For indicator 19 «VISUAL ALARM» indicating of actuation of one of the light alarms is of more priority than indication of a fault in the connection circuit of another visual alarm.

\*\* – When the units of versions 3.02, 3.05, 3.06, 3.07, and 3.08 are being updated up to the version 3.51 this indicator shows solid amber light. In this case when a fault of the backup battery has occurred the indicator pulses while in normal conditions it is off (see Table 2.31)

Performance of the indicators is described below (see Section 2.17).

2.9 There are 17 function pushbuttons and a key switch on the faceplate of the S2000-ASPT. The arrangement of the pushbuttons is shown in Figure 2.2. Destination of the pushbuttons is described Table 2.3.



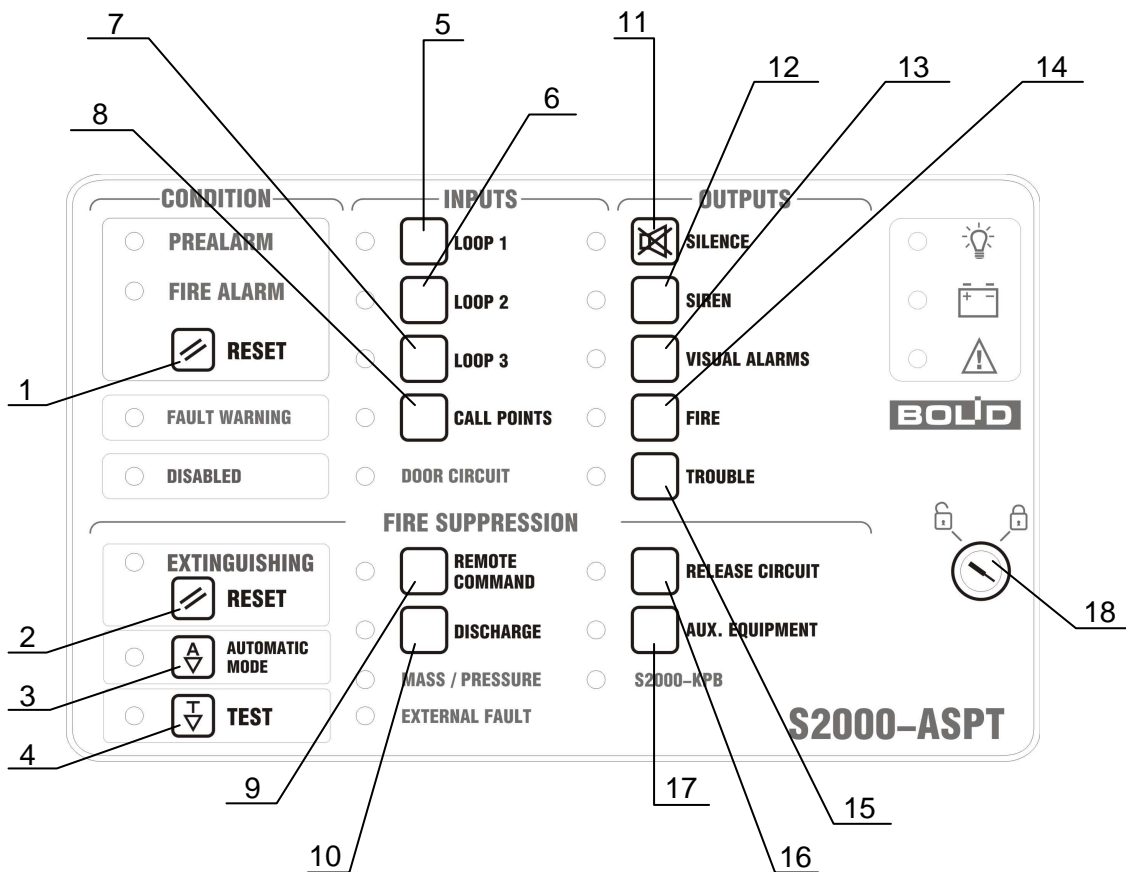



Figure 2.2 Push Buttons and Key Switch

Table 2.3 Push Button Functions

No	Button	Functions
1	Fire RESET	Resets Fire Alarm mode <sup>2)</sup>
2	Extinguishing RESET	Resets Extinguishing mode <sup>2)</sup>
3	AUTOMATIC MODE	Switches on and off the automatic release mode, VA3 <sup>2)</sup>
4	TEST	Initiates Indication Test mode <sup>2,3)</sup>
5	LOOP 1	Disables (enables) inputs LOOP1, LOOP2, LOOP3 <sup>2,3)</sup>
6	LOOP 2	
7	LOOP 3	
8	CALL POINTS	Disables (enables) manual release stations <sup>2,3)</sup>
9	REMOTE COMMAND	Disables (enables) release commands from the network controller <sup>2,3)</sup>
10	DISCHARGE	Disables (enables) the input to monitor pressure detector conditions <sup>2,3)</sup>
11	SILENCE	Disables (enables) the internal sounder <sup>1)</sup>
12	SIREN	Disables (enables) the circuit to control an external sounder <sup>2,3)</sup>
13	VISUAL ALARMS	Disables (enables) the circuits to control VA1, VA2, VA3 <sup>2,3)</sup>
14	FIRE	Disables (enables) control of the FR output <sup>2,3)</sup>
15	FAULT	Disables (enables) control of the FLT output <sup>2,3)</sup>
16	RELEASE CIRCUIT	Disables (enables) the release circuit <sup>2,3)</sup>
17	AUX.EQUIPMENT	Disables (enables) control of the NO-NC-C relay <sup>2,3)</sup>
18	Key Switch	Disables / activates push button actions by means of the key supplied

*Note: Symbols <sup>1,2,3)</sup> denote the relevant access levels which allows actuation of the specified functions (see Section 2.11).*

2.9.1 When the button  1 - Fire RESET is pushed (access level – 2) the S2000-ASPT discards all received fire alarms and arms the alarm loops which is in Fire Alarm mode.

2.9.2 When the button  2 – Extinguishing RESET is pushed (access level – 2) the S2000-ASPT resets the Extinguishing mode, de-energizes the release circuit («R»), and triggers the release outputs of the S2000-KPB into the initial state.

2.9.3 When the button  3- AUTOMATIC MODE is pushed (access level – 2) the S2000-ASPT switches on or off the automatic release mode of the fire suppression system. If the automatic release mode was set on, pushing the button switches it off and vice versa. If the automatic release mode is disabled (for example, as a result of a response in the door sensor circuit) then pushing the button causes the internal sounder to play a long sound.

2.9.4 When the button  4 - «TEST» is pushed (access level – 2) the S2000-ASPT proceeds to the Test Indication mode. To get more information please refer to Section 2.16.7.

2.9.5 Pushing one of the buttons 5, 6, 7, 8, 9, 10 (access levels – 2) disables (disarms) or enables (arms) the following relevant input of the S2000-ASPT:

- Button 5: Monitoring of fire alarm LOOP 1;
- Button 6: Monitoring of fire alarm LOOP 2;
- Button 7: Monitoring of fire alarm LOOP 3;
- Button 8: Input of the manual release station circuit;
- Button 9: Input of remote commands (remote release by a network controller command);
- Button 10: Input of the pressure sensor circuit.

2.9.6 When the button  11 - «SILENCE» is pushed (access level – 1) the internal sounder of the S2000-ASPT is silenced (disabled). Next pushing of the button or any event to be accompanied with a sound having occurred (see Section 2.10) will automatically enables the sounds again. When the S2000-ASPT is in the Pre-discharge Delay mode the internal sounder cannot be silenced.

2.9.7 Pushing one of the buttons 12, 13, 14, 15, 16, 17 (access level 2) disables (locks) or enables (unlocks) the relevant output of the S2000-ASPT:

- Button 12: SA output (siren);
- Button 13: Outputs VA1 (EXIT), VA2 (KEEP OUT); VA3 (AUTOMATICS OFF)
- Button 14: Fire output;
- Button 15: Fault output;
- Button 16: Release circuit output;
- Button 17: The output for controlling auxiliary equipment (NO-NC-C relay).

2.9.8 The Locked position of the key switch denoted by the sign  means that the S2000-ASPT cannot be controlled manually from its front plate. This is available for the access level 1.

2.9.9 The Unlocked position of the key switch denoted by the sign  enables controlling the S2000-ASPT operation by pushing buttons on its front plate. This is available for the access level 2.

2.10 The S2000-ASPT is equipped with an internal sounder which operates in the following modes:

- Plays a melody when power has been applied to the unit;
- Plays a melody when the S2000-ASPT enters to the Indication Test or Self-Diagnostic mode;
  - Plays a long sound on a request for control which is rejected;
- Plays short single two-tone variable-frequency sounds when the S2000-ASPT enters the Pre-discharge Delay mode (Pre-discharge Time Hold);
- Plays a solid two-tone sound when the S2000-ASPT enters:
  - The Fire Alarm mode;
  - The Release mode;
- Plays single-tone interrupted sounds:
  - When a fault has been detected (see Section 2.7.1);

- When the S2000-ASPT starts being supplied by the batteries (when the mains power has been repaired the sounder silences automatically);
- In case of a battery fault (when the backup power is repaired the sounder silences automatically);
- In case of a system failure of the unit;
- Plays double-tone interrupted sounds when one of the unit's alarm loops proceeds to the Fire Prealarm mode.

2.11 The S2000-ASPT provides the following local access levels for indication and control which describe permissions of users to access specific unit functions.

2.11.1 **Access Level 1** is intended for operating personnel and safety officers responsible for safety supervision that might be expected to investigate and respond to a fire alarm or a fault warning.

The following operations are available for a user assigned with the access level 1:

- Monitoring of performance of the light indicators on the unit/s front plate;
- Silencing the built-in sounder, if activated.

This access level is associated with the position  of the key switch.

2.11.2 **Access Level 2** is expected to be used by persons having a specific responsibility for operating fire protection equipment, and who are trained and authorized to operate the S2000-ASPT in the following conditions:

- Quiescent mode;
- Fault;
- Prealarm;
- Fire Alarm;
- Pre-discharge Delay;
- Pre-discharge Time Hold;
- Release mode;
- Extinguishing.

The access level 2 makes available for user all the operations of the access level 1 plus the following actions:

- Resetting the Fire Prealarm and the Fire Alarm modes;
- Resetting the Extinguishing mode, the Pre-discharge Delay mode, the Pre-discharge Time Hold mode, and the Release mode;
- Enabling (disabling) the automatic release mode.

Additionally, the specialists are authorized to disable the inputs and outputs and initiate the test indication mode of the S2000-ASPT.

This access level is associated with the position  of the key switch.

To gain an access at this access level the provided electric-contact lock key is used.

2.11.3 **Access Level 3** is expected to be used by technical specialists who configure and assist in operation of the unit and maintain the S2000-ASPT.

To get the rights at this access level the provided mechanical lock key is to be used (the key for the mechanical lock on the front door of the S2000-ASPT).

2.11.4 When the S2000-ASPT operates in cooperation with a network controller an additional **access level 4** defines the rights of Orion Pro Workstation operator of S2000M panel operator. This access level permits a user to control the S2000-ASPT remotely.

In order to get access at access level 4 a personal password enrolled in the database of the network controller must be typed from the keypad of the panel or the keyboard of the PC.

2.12 The S2000-ASPT provides monitoring conditions for the following inputs (including virtual ones):

- Input 0 : Monitoring conditions of the tamper switch of the S2000-ASPT (virtual);
- Input 1 : Monitoring conditions of the fire alarm loop 1 (LOOP 1);
- Input 2 : Monitoring conditions of the fire alarm loop 2 (LOOP 2);

- Input 3 : Monitoring conditions of the fire alarm loop 3 (LOOP 3);
- Input 4 : Monitoring conditions of the door position sensor (DOOR CIRCUIT);
- Input 5 : Monitoring conditions of the manual release station (CALL POINTS);
- Input 6 : Monitoring conditions of the pressure detector;
- Input 7 : Monitoring conditions of mains power (220 V) (virtual);
- Input 8 : Monitoring conditions of backup power supply (battery) (virtual);
- Input 9 : Monitoring the current release mode (virtual);
- Input 10: Monitoring for current operation mode of the unit (virtual);
- Input 11: Monitoring for status of the remote release mode (virtual);
- Input 12: Monitoring for fire equipment fault circuit (EXTERNAL FAULT);
  
- Input 20: Integrated monitoring of conditions of the tamper switch and summarized power supply conditions of the first S2000-KPB (virtual);
- Input 21: Monitoring conditions of Input 1 of the first S2000-KPB;
- Input 22: Monitoring conditions of Input 2 of the first S2000-KPB;
  
- Input 30: Integrated monitoring of conditions of the tamper switch and summarized power supply conditions of the second S2000-KPB (virtual);
- Input 31: Monitoring conditions of Input 1 of the second S2000-KPB;
- Input 32: Monitoring conditions of Input 2 of the second S2000-KPB;
  
- Input 40: Integrated monitoring of conditions of the tamper switch and summarized power supply conditions of the third S2000-KPB (virtual);
- Input 41: Monitoring conditions of Input 1 of the third S2000-KPB;
- Input 42: Monitoring conditions of Input 2 of the third S2000-KPB;
- ...
- Input 170: Integrated monitoring of conditions of the tamper switch and summarized power supply conditions of the 16-th S2000-KPB (virtual);
- Input 171: Monitoring conditions of Input 1 of the 16-th S2000-KPB;
- Input 172: Monitoring conditions of Input 2 of the 16-th S2000-KPB.

2.12.1 The S2000-ASPT provides monitoring for three alarm loops with the parameters below:

- The resistance of alarm loop wires without regards to the termination resistance doesn't exceed 100 ohms;
- The leakage resistance between the loop wires of between each wire and the earth is 50 K.

2.12.1.1  $1/2 W - 4.7 K \pm 5\%$  Ohm termination resistors supplied must be connected into the alarm loops.

2.12.1.2 The S2000-ASPT provides the alarm loop inputs in the Quiescent mode with dc voltage in the range of 24 V to 19 V taking into account current consumption of active detectors in the range of 0 to 3 mA respectively.

2.12.1.3 If a short circuit failure has occurred in one of the alarm loops the S2000-ASPT provides at other alarm loop inputs the dc voltage in accordance with Section 2.12.1.2. It is recommended to avoid situations when short circuit failures can occur in more than two alarm loops the same time.

2.12.1.4 The S2000-ASPT provides limitation of the short-circuit current in any of its alarm loops by the value of 27 mA max.

2.12.1.5 The effective value of ripple voltage in an alarm loop doesn't exceed 20 mV.

2.12.1.6 The S2000-ASPT recognizes the following states of the alarm loops:

- Operation;
- Response (activation);
- Open Circuit;
- Short Circuit.

Status of an alarm loop depends on its parameters as shown in Table 2.4.

**Table 2.4** Parameters of the Alarm Loops for Various States

Alarm Loop Type	Alarm Loop Parameters			
	Operation	Response (Activation)	Open Circuit	Short Circuit
1 – Fire Smoke Two-Threshold*	Resistance 2.2 to 5.4 kΩ Smoke detectors consume current from 0 to 3 milliamp	Resistance 0.1 to 1.8 kΩ	Resistance > 6.6 kΩ	Resistance < 100 Ω
2 – Fire Combined Single-Threshold** (smoke and heat)	Resistance 2.2 to 5.4 kΩ Smoke detectors consume current from 0 to 1.2 milliamp	Resistance 0.1 to 1.8 kΩ or 6.6 to 14.4 kΩ	Resistance > 16 kΩ	Resistance < 100 Ω
3 – Fire Heat Two-Threshold*	Resistance 2.2 to 5.4 kΩ	Resistance 6.6 to 25 kΩ	Resistance > 30 kΩ	Resistance < 1.8 kΩ

\* - Double response is recognizable

\*\* - Double response is not recognizable

The resistance of an alarm loop can be estimated based on the ATD-value measured by the S2000-ASPT for this alarm loop using the formula below:

$$R_{loop} = \frac{280.8}{ATD} - 1, [K\Omega],$$

Where  $R_{loop}$  is the actual resistance value of the alarm loop, and

**ATD** is the measured analog-to-digital converted value of the alarm loop resistance.

An ATD-value can be read by means of the network controller from the loop control menu (for an S2000M panel).

2.12.1.7 The S2000-ASPT provides powering active two-wire detectors through its alarm loops. The maximum number of the detectors to be wired into a single alarm loop can be estimated by formula:

$$N = I_{max} / i, \text{ where:}$$

**N** stands for the number of detectors within a single alarm loop and

**I<sub>max</sub>** stands for the maximum load current

(I<sub>max</sub> = 3 milliamp for a loop of Type 1; I<sub>max</sub> = 1.2 milliamp for a loop of Type 2)

**i** stands for the current in mA consumed by each detector in the quiescent mode

If an alarm loop of Type 1 (fire smoke two-threshold) is in use then the wired detectors must be operable in case of loop voltage's having fallen down to 12 V.

2.12.1.8 The integration time (the time of activation of an alarm loop which is fixed by the unit) for the alarm loops LP1...LP3 is 300 milliseconds.

2.12.2 The S2000-ASPT provides monitoring the door sensor circuit, the manual call point circuit, the pressure detector circuit, and the fire equipment fault circuit if:

- The resistance of the wires without regard to termination resistors doesn't exceeds 100 Ω;
- The leakage resistance between the circuit wires and/or between each wire and the earth is at least 50kΩ.

2.12.2.1 Termination resistors 0.5W 4.7±5% kΩ should be wired into the circuits connected to the monitored inputs.

2.12.2.2 The S2000-ASPT recognizes the following states of the door sensor circuit, the manual call point circuit, the pressure detector circuit, and the fire equipment fault circuit:

- OK (Operation);
- Activation;
- Open Circuit;
- Short Circuit.

The states of the door sensor circuit and the manual call point circuit are recognized depending on the circuit resistance values as specified in Table 2.5.

2.12.2.3 The integration time (the time of actuation registered by the S2000-ASPT) is 1 s for the manual release circuit and 300 ms for other monitored circuits.

**Table 2.5** Parameters of the Door Sensor Circuit and the Call Points Circuit

<b>Parameters of the Monitored Circuits in Various States</b>			
<b>Operation</b>	<b>Activation</b>	<b>Open Circuit</b>	<b>Short Circuit</b>
The resistance of the circuit is between 2.2 kΩ and 5.4 kΩ	The resistance of the circuit is between 200 Ω and 1.8 kΩ or between 6.6 kΩ and 25 kΩ	The resistance of the circuit is higher than 30 kΩ	The resistance of the circuit is less than 100 Ω

The resistance of a monitored circuit can be estimated based on its measured ATD value by using the formula below:

$$R_{mc} = \frac{ATD}{126.4 - 0.53 \cdot ATD}, [\text{K}\Omega], \text{ where}$$

$R_{mc}$  stands for the actual resistance of the monitored circuit, and  $ATD$  is the measured ATD-value of the circuit.

An ATD-value can be read by means of the network controller from the loop control menu (for an S2000M panel).

2.13 The S2000-ASPT provides monitoring conditions of the following output circuits:

- Output 1 : Visual alarm 1 (EXIT light sign);
- Output 2 : Visual alarm 2 (KEEP OUT light sign);
- Output 3 : Visual alarm 3 (AUTOMATIC OFF light sign);
- Output 4 : Audible alarm (fire siren);
- Output 5 : Release circuit;
  
- Output 21: Output 1 of the first connected S2000-KPB;
- Output 22: Output 2 of the first connected S2000-KPB;
- Output 23: Output 3 of the first connected S2000-KPB;
- Output 24: Output 4 of the first connected S2000-KPB
- Output 25: Output 5 of the first connected S2000-KPB;
- Output 26: Output 6 of the first connected S2000-KPB
  
- Output 31: Output 1 of the second connected S2000-KPB;
- Output 32: Output 2 of the second connected S2000-KPB;
- Output 33: Output 3 of the second connected S2000-KPB;
- Output 34: Output 4 of the second connected S2000-KPB;
- Output 35: Output 5 of the second connected S2000-KPB;
- Output 36: Output 6 of the second connected S2000-KPB;
- ...
- Output 171: Output 1 of the 16-th connected S2000-KPB;
- Output 172: Output 2 of the 16-th connected S2000-KPB;
- Output 173: Output 3 of the 16-th connected S2000-KPB;
- Output 174: Output 4 of the 16-th connected S2000-KPB;
- Output 175: Output 5 of the 16-th connected S2000-KPB;
- Output 176: Output 6 of the 16-th connected S2000-KPB.

2.13.1 The S2000-ASPT monitors outputs for connecting light and sound alarms VA1, VA2, VA3, SA and the release circuit for open and short circuit failures when they are switched on and also when they are switched off.

2.13.2 The rated switched voltage for each output is (24±2) V.

2.13.3 The maximum switched current for each output is:

- 1 A in continuous mode;
- 2 A within 2 s in pulse mode.

2.13.4 The maximum circuit control current for an output is 1.5 mA.

2.13.5 The S2000-ASPT recognizes the following states of the release circuit and the notification appliance circuits:

- OK (Operation);
- Open Circuit;
- Short Circuit.

States of outputs depend on the voltage at the negative terminal of the notification appliance control output relative to the 0V terminal as shown in Table 2.6.

**Table 2.6** Parameters of the Notification Appliance Connection Circuits

<b>The States of Connection Circuits Depending on the Voltage at the Output Negative Terminal</b>				
<b>OK</b>	<b>Open Circuit</b>		<b>Short Circuit</b>	
	<i>On</i>	<i>Off</i>	<i>On</i>	<i>Off</i>
The voltage between 0.35 V to 4.0 V	Less than 0.05 V	More than 4.1 V	More than 4.5 V	Less than 0.3 V

2.13.6 If a short circuit failure has been detected for an output which is switched off then the output cannot be switched on until the failure is repaired.

If, otherwise, a short circuit failure has been detected for an output which is switched on then the output is switched off immediately. Since 60 seconds after repairing the failure the unit automatically tries to switch on the output again.

2.13.7 If an open circuit failure has been detected for an output then this output can be controlled.

2.13.8 The integration time for making a decision about a short circuit failure of an active output is 70 ms. Other integration times for recognizing output conditions are 300 ms.

2.14 When the S2000-ASPT is used in cooperation with a gaseous fire extinguishing system then an actuation of the system (release) is considered to be successful on receiving a response of the pressure detector included into the pressure detector circuit. If a release pulse has been given but the pressure detector doesn't trigger or the pressure detector circuit is out of service then the release is considered to be faulty. In this event the duration of the release pulse should be in accordance with the maximum time of discharging extinguishing agent for this type of the fire suppression appliance.

2.15 To adjust the S2000-ASPT to be used in a specific fixed fire extinguishing system a number of parameters stored in its non-volatile memory can be programmed.

There are four groups of configuration parameters of the S2000-ASPT:

- The parameters of alarm loops and monitored circuits;
- The parameters for control of the NO-NC-C relay;
- The unit parameters;
- The system parameters.

2.15.1 The configuration parameters of the alarm loops and monitored circuits are shown in Table 2.7.

**Table 2.7** Configuration Parameter of Inputs

Parameter	Description	Value Range
Input Type	Determines the tactics for monitoring the alarm loop and types of the detectors to be connected into the alarm loop (normally open or normally closed detectors, recognition of responses of two or more detectors in a single alarm loop)	1 – Fire Smoke Two-Threshold*; 2 – Fire Combined Single-Threshold** (smoke and heat); 3 – Fire Heat Two-Threshold*;
Input Analysis Delay	Defines a pause before the unit starts analyzing the alarm loop again after resetting power. Is defined by a time required to restore operation mode of two-wire detectors after switching power off and on again	3...255 s
Input Requery Prohibition	Disables repeated queries to a tripped detector	On / Off
Recovery Time	Defines the time since the moment of recovering of the monitoring circuit until the monitored circuit is considered as being operative	0...255 s

\* - Two responses are recognized

\*\* - Two responses are not recognized

**Input Type** defines how the unit monitors the alarm loop and what type of detectors can be wired into the alarm loop. The integration time for the first, the second, and the third alarm loop is 1 s; the unit recognizes activation (responses), short circuit failures, and open circuit failures. When a smoke (normally open) detector has responded, the S2000-ASPT sends a Fire Signal message and **queries the detector once more**: shuts off power voltage for the alarm loop and waits a minute for a second response of the detector. If the detector has not entered its initial state or has responded repeatedly within one minute then the S2000-ASPT enters the Fire Prealarm status. Otherwise, the unit remains in the Operation mode.

When a heat (normally closed) detector has responded, the S2000-ASPT enters the Fire Prealarm mode immediately. For inputs of Types **1** and **3** a double response is recognized, that is the unit realizes that two or more detectors have tripped within the single alarm loop. In this case the S2000-ASPT proceeds from the Armed state or the Fire Prealarm state to the Fire Alarm status only after a second detector has tripped within the alarm loop. For an input of Type **2** only activation of one detector is recognized. When a detector has tripped the S2000-ASPT enters the Fire Prealarm status. The unit can enter the Fire Alarm status only if once more input is in the Fire Prealarm status. Unit's being in the Fire Alarm mode is a condition to activate the fixed fire extinguishing system. So, for inputs of the type **1** and type **3** the fixed fire extinguishing system can be automatically actuated when two detectors in the same alarm loop have triggered while for the input of the type **2** the fire extinguishing system can be automatically actuated when two detectors have triggered in two alarm loops independently.

A loop of the type **1** is designed to include normally open fire detectors powered via the alarm loop with a residual voltage at the responded detector 4.5 – 8 V and minimum operating voltage 12 V max. An additional resistor should be brought in series with the detector.

A loop of the type **2** can include both smoke (normally open) detectors without additional resistors and heat (normally closed) detectors. A shunt resistor should be brought in parallel across the contacts of a heat detector as shown in Appendix C.

The loop type **3** is designed to include fire detectors with normally closed contacts. A shunt resistor should be brought in parallel across the contacts of such a detector as shown in Appendix C.



**Loop Analysis Delay** gives a time during which the S2000-ASPT doesn't consider loop resistance changes after resetting power. The value of this delay is defined by detector pre-operating time, its minimum value being equal to 3 s.

If necessary, the function of repeated request of an actuated detector can be disabled by setting the **Loop Requery Prohibition** parameter on. This feature is suitable if, for example, normally opened four-wire detectors with separate power supplying are in use.

The **Recovery Time** parameter concerns the following monitored inputs: the door sensor circuit, the pressure detector circuit, the fire equipment fault circuit. Changing this parameter for specific equipment provides increasing or decreasing the time for the unit to react after recovering the circuit after its activation. This, in turns, provides avoiding unnecessary messages about changes of circuit states due to transient processes and about people's passing through a door in case of repetitive activations and recovering of the door sensor circuit.

2.15.2 Configuration parameters of the NO-NC-C relay can be shown in Table 2.8.

**Table 2.8** Configuration Parameters of NO-NC-C Relay

Parameter	Description	Value Range
Control Program	Defines the performance of the relay NO-NC-C depending on the states of the related inputs and outputs and gives the initial state of the relay	0...30
Activation Time	The time for which the relay NO-NC-C will be switched on or off for those control programs which suppose activation the relay for a limited time	0 to 8192 s (to 2 h 16 min 32 s) in increments of 0.125 s
Link the Relay With	Links the relay NO-NC-C with inputs and outputs	–

**Control Program** defines the way the relay NO-NC-C will operate depending on the conditions of the inputs and outputs related to this relay (*local control*) or the initial state of the relay after power has been applied to the S2000-ASPT and until a first network controller command is received (*centralized control*). All available control programs are shown in Table 2.9.

**Activation Time** gives the time of relay's being switched on or off for the control programs with a limited time of operation. The maximum time of activation of a single relay is 65535 intervals of 0.125 s (8192 s).

**Table 2.9** Control Programs for NO-NC-C Relay

No.	Control Program	Description	Initial State
0	Remote Control	No conditions to control the relay	Off
1	Switch On	In case of a Fire Alarm the relay is switched on	Off
2	Switch Off	In case of a Fire Alarm the relay is switched off	On
3	Switch On for a Time	In case of a Fire Alarm the relay is switched on for a specified time	Off
4	Switch Off for a Time	In case of a Fire Alarm the relay is switched off for a specified time	On
5	Blink (Off Is Initial Position)	In case of a Fire Alarm the relay pulses (on for 0.5 s / off for 0.5 s)	Off
6	Blink (On Is Initial Position)	In case of a Fire Alarm the relay pulses (on for 0.5 s / off for 0.5 s)	On
7	Blink for a Time (Off Is Initial Position)	In case of a Fire Alarm the relay pulses (on for 0.5 s / off for 0.5 s) within a specified time	Off
8	Blink for a Time (On Is Initial Position)	In case of a Fire Alarm the relay pulses (on for 0.5 s / off for 0.5 s) within a specified time	On

No.	Control Program	Description	Initial State
13	Fire Output	In case of a Fire Alarm of a Fire Prealarm the relay is switched on; else the relay is switched off (open)	*
14	Fault Output	If a related input or output is in Fault conditions (short or open circuit failure), Arming Failed or Disarmed (Disabled) then the relay is switched off; else the relay is switched on	*
15	Fire Lamp	In case of a Fire Alarm the relay pulses twice per second (on for 0.25 s / off for 0.25 s). In case of a Fire Prealarm the relay flashes once per second (on for 0.25 s / off for 0.75 s). In case of an Arming Failed the relay pulses once per second (on for 0.5 s / off for 0.5 s). In case of a Fault the relay flashes once per two seconds (on for 0.25 s / off for 1.75 s). If all the related inputs/outputs are OK the relay is switched on; else the relay is switched off	*
19	Switch On for a Time upon Arming	If any related alarm loop has just been armed the relay is switched on for a given time	Off
20	Switch Off for a Time upon Arming	If any related alarm loop has just been armed the relay is switched off for a given time	On
21	Switch On for a Time upon Disarming	If any related alarm loop has just been disarmed the relay is switched on for a given time	Off
22	Switch Off for a Time upon Disarming	If any related alarm loop has just been disarmed the relay is switched off for a given time	On
23	Switch On for a Time if Arming Failed	If arming of any related alarm loop has just failed the relay is switched on for a given time	Off
24	Switch Off for a Time if Arming Failed	If arming of any related alarm loop has just failed the relay is switched off for a given time	On
27	Switch On upon Disarming	If at least one related loop is disarmed the relay is switched on	Off
28	Switch Off upon Disarming	If at least one related loop is disarmed the relay is switched off	On
29	Switch On upon Arming	If at least one related loop is armed the relay is switched on	Off
30	Switch Off upon Arming	If at least one related loop is armed the relay is switched off	On

**Notes:**

\* – The initial state of the relay is defined by the state of the group of the related zones.

A state «Off» implies the following conditions of the relay contacts:

- NO-C: open;
- NC-C: closed.

A state «On» implies the following conditions of the relay contacts:

- NO-C: closed
- NC-C: open.

The NO-NC-C relay can be associated with the inputs listed below:

- Input 1 : Monitoring conditions of the fire alarm loop 1 (LOOP 1);
- Input 2 : Monitoring conditions of the fire alarm loop 2 (LOOP 2);
- Input 3 : Monitoring conditions of the fire alarm loop 3 (LOOP 3);
- Input 4 : Monitoring conditions of the door position sensor (DOOR CIRCUIT);

- Input 5 : Monitoring conditions of the manual release station (CALL POINTS);
- Input 6 : Monitoring conditions of the pressure detector;
- Input 11: Monitoring for status of the remote release mode (virtual);
- Input 12: Monitoring for fire equipment fault circuit (EXTERNAL FAULT).

The NO-NC-C relay can be associated with the outputs listed below:

- Output 1 : visual alarm 1 (EXIT light sign);
- Output 2 : visual alarm 2 (KEEP OUT light sign);
- Output 3 : visual alarm 3 (AUTOMATIC OFF light sign);
- Output 4 : audible alarm (fire siren);
- Output 5 : release circuit;

In fact, it is reasonable to link the relay NO-NC-C with one or more outputs only for the control program 14, Fault Output.

If in the S2000-ASPT configuration the relay is linked to an alarm loop then remote control commands from the network controller are ignored. **Local control of the relay is of more priority than centralized control.**

To control the relay centrally (by network controller commands):

- Clear all links between the relay NO-NC-C with the inputs and the outputs of the unit;
- Define any control program with a proper initial state («On» or «Off») for the relay;
- In the configuration of the network controller link the relay NO-NC-C (relay No.8) with the relevant partitions and define the proper control program, activation delay, and activation time.

When the relay is linked with no alarm loops **Control program** defines only the initial state of the relay - the state which the relay is switched to when power has been applied to the S2000-ASPT. In general, if the relay is expected to be controlled centrally then a **Control Program** which implies Off initial relay status (for example, the program 1 – Switch On) is given for the relay in the unit configuration. Since power is applied to the unit and until a centralized control command is received which switches the relay to the state defined by the current condition of the related partitions some time can expire, so if a central control program which implies the On initial state is in use then it makes sense to switch the relay to the On state just after powering up the unit. For doing so, in the unit configuration assign the relay with any control program with the On initial state, for example the program 2 – Switch Off.

2.15.3 Configuration parameters of the S2000-ASPT define the performance of the unit and parameters of activation of the fixed fire extinguishing system.

The configuration parameters of the unit are shown in Table 2.10.

**Table 2.10** Configuration Parameters of the S2000-ASPT

Parameter	Description	Value Range
Siren Sounding Time	Defines the time to activate the sound alarm, connected to the SA output	0...255 s
Release Pulse	Defines the duration of release pulse	0...255 s
Automatic Pre-discharge Delay	Defines a delay for generating a release pulse when the fire suppression system is activated by tripping of automatic fire detectors	0...255 s
Remote Pre-discharge Delay	Defines a delay for generating a release pulse when the fire suppression system is activated by a manual release station or by a remote command from the network controller	0...255 s
Automatic Mode Recovery	Allows in Quiescent mode auto restoring of automatic release mode just after the door sensor circuit has been OK	On / Off

Parameter	Description	Value Range
Automatic Release Recovery	In the automatic release mode provides restoring of Pre-Discharge Delay mode just after the door sensor circuit has been OK	On / Off
Remote Release Priority	Enables remote release even if a door sensor has activated or the door sensor circuit has failed	On / Off
Disable Two Prealarm Release	Provides disabling automatic release when two various alarm loops are in Fire Prealarm mode	On / Off
Disable Monitoring for Pressure Detector	Provides disabling of function of monitoring the pressure detector circuit when it is not necessary	On / Off
Master Key Provided Access	The parameter is not used for the current version	Off
Disable Auxiliary Alarms	Causes the unit not to generate messages about conditions of the door sensor circuit	On / Off
Continuous operation of VA1 (EXIT)	Provides steady operation for notification appliances with pulse operation	On / Off
Continuous operation of VA2 (KEEP OUT)		On / Off
Continuous operation of SA (Siren)		On / Off
S2000-KPB Addresses	Defines the addresses of the S2000-KPB units which the S2000-ASPT controls (which deals with this discharge area)	Up to 16 addresses within the range of 1 to 127

The parameter **Siren Sounding Time** gives the duration of activation of the external audible notification appliance (the siren) when the S2000-ASPT enters the Fire Alarm mode or the Pre-discharge Delay mode.

The **Automatic (Remote) Pre-discharge Delay** parameters define the duration of delay (in seconds) between release conditions having occurred and generating a pulse to release extinguishing agent in the fire extinguishing system. The unit provides setting different delay values for automated discharge and remote discharge (from a manual release station or by a network controller command).

If **Automatic Mode Recovery** is set on then the S2000-ASPT automatically restores the automatic release mode after a door circuit has been repaired (the door has been closed). If the parameter in question is set off then actuation of the door sensor leads to disabling of automatic release, this mode being kept even after trouble having restored.

If **Automatic Release Recovery** is set on then the S2000-ASPT automatically restores the Pre-discharge Delay mode if during automatic release the door sensor circuit has been violated and repaired again. If this parameter is set off, in case of automatic release mode violation of the door sensor circuit aborts releasing, and the extinguishing system will not be discharged even after the door circuit is restored.

It is sensible to set this parameter on if Automatic Mode Recovery has been set on.

The **Remote Release Priority** parameter prioritizes the remote release mode above blocking release upon any fault or opening of the door sensor circuit. This parameter being set on, a remote release command cannot be disabled by opening the door, but only by reset.

The parameter **Disable Two Prealarm Release** prevents unit's proceeding to the Fire Alarm mode if two various alarm loops are in the Prealarm mode. This parameter provides implementing the

tactics when the system can be actuated automatically only when two detectors in a single alarm loop have tripped.

**Disable Monitoring for Pressure Detector** provides disabling of monitoring the pressure detector circuit if it is not necessary (for example, for dry chemical or aerosol fire suppression systems).

A set of **S2000-KPB Addresses** define the S2000-KPB modules which expands release outputs for the S2000-ASPT. The S2000-KPB units are connected to the S2000-ASPT via the RS-485-2 interface port of the last one. Each S2000-KPB has to be assigned with a unique network number ranged from 1 to 127. The maximum number of S2000-KPB to be connected to a single S2000-ASPT is 16. When release conditions have occurred and Automatic / Remote Pre-discharge Delay has expired the S2000-ASPT gives the discharge command to each of the connected S2000-KPB units. The durations of discharge pulse as well as pauses between activations of the S2000-KPB outputs are given in the S2000-KPB configurations.

2.15.4 System configuration parameters define settings for the S2000-ASPT to operate as part of an Orion ISS.

The configuration parameters of the unit are shown in Table 2.11.

**Table 2.11** System Configuration Parameters of the S2000-ASPT

Parameter	Description	Value Range
1	2	3
Network Address	Defines the address of the S2000-ASPT for connection to the RS-485-1 interface bus	1...127
Response Pause	Defines the time for the S2000-ASPT to respond on a request of the network controller	From 1.5 ms to 500 ms in increments of 0.125 ms

**Network Address** is designed to uniquely identify the S2000-ASPT as part of an Orion ISS. The unit sends messages to and receives commands from the network controller only using the address specifying by this parameter. A network address must be unique for each unit.

Customizing **Response Pause** provides operating the unit within a system with a sophisticated network topology where long layover can exist, for example, while converting RS-485 data into other interfaces intended for transmission over local area networks, fiber optic channels, or radio channels.

The current settings of Network Address and Response Pause can be unset to their factory (default) values by pressing the unit tamper switch down by a special way: three times for a long time and once for a short time (dash dash dash dot).<sup>2)</sup>

2.15.5 The factory settings of the configuration parameters of the S2000-ASPT are shown in Tables 2.12 – 2.15.

**Table 2.12** Factory Configuration of the S2000-ASPT

Parameter	Factory Value
Input 1 Type	2
Input 2 Type	2
Input 3 Type	2
Input 1 Requery Prohibition	Off
Input 2 Requery Prohibition	Off
Input 3 Requery Prohibition	Off
Input 1 Analysis Delay, s	3
Input 2 Analysis Delay, s	3
Input 3 Analysis Delay, s	3
Recovery Time, s for the door sensor circuit	15
Recovery Time, s for the pressure detector circuit	15

<sup>2)</sup> A *long press* means pressing the tamper switch down and holding it pressed for longer than 1.5 s. A *short press* means pressing the tamper switch down and holding it pressed for (0.1...0.5) s. Pauses between presses shall be no shorter than 0.1 s and no longer than 0.5 s.

Parameter	Factory Value
Recovery Time, s for the external fault circuit	15
Siren Sounding Time, s	120
Release Pulse, s	15
Automatic Pre-discharge Delay, s	30
Remote Pre-discharge Delay, s	15
Automatic Mode Recovery	Off
Automatic Release Recovery	Off
Remote Release Priority	Off
Disable two Prealarm Release	Off
Disable Monitoring for Pressure Detector	Off
Master Key Provided Access	Off
Disable Auxiliary Alarms	Off
Continuous operation of VA1 (EXIT)	Off
Continuous operation of VA2 (KEEP OUT)	Off
Continuous operation of SA (Siren)	Off

**Table 2.13** Default Addresses of the Connected S2000-KPB

Number	1	2	3	4	5	6	7	8	9	10	11	12	13	14	15	16
Address	0	0	0	0	0	0	0	0	0	0	0	0	0	0	0	0

**Table 2.14** Default Settings of the System S2000-ASPT Parameters

No.	Parameter	Default Value
1	Network Address	127
2	Response Pause	1.5 ms

**Table 2.15** Factory Settings of the NO-NC-C relay

Number	1	2	3	4	5	6	7	8	9	10	11	12	13
Link the Relay With	+	+	+	+	+	+	+	+	+	+	+	+	+
Control Program	13: Fire Output												
Activation Time	Unlimited												

**Note:** The Numbers mean the following:

- 1 – Input 1 : Monitoring conditions of the fire alarm loop 1 (LOOP 1);
- 2 – Input 2 : Monitoring conditions of the fire alarm loop 2 (LOOP 2);
- 3 – Input 3 : Monitoring conditions of the fire alarm loop 3 (LOOP 3);
- 4 – Input 4 : Monitoring conditions of the door position sensor (DOOR CIRCUIT);
- 5 – Input 5 : Monitoring conditions of the manual release station (CALL POINTS);
- 6 – Input 6 : Monitoring conditions of the pressure detector;
- 7 – Input 12: Monitoring for fire equipment fault circuit (EXTERNAL FAULT);
- 8 – Output 5 : Release circuit;
- 9 – Output 1 : Visual alarm 1 (EXIT light sign);
- 10 – Output 2 : Visual alarm 2 (KEEP OUT light sign);
- 11 – Output 3 : Visual alarm 3 (AUTOMATIC OFF light sign);
- 12 – Output 4 : Audible alarm (fire siren);
- 13 – Output 11: Remote release command.

2.16 The S2000-ASPT provides operation in the following modes:

- Pre-operation;
- Device Failure;
- Quiescent mode;
- Fault;
- On Batteries;
- Battery Fault;
- Disabled;
- Indication Test;
- Self-Diagnostic;
- Fire Pre-alarm;
- Fire Alarm;
- Pre-discharge Delay;
- Pre-discharge Time Hold;
- Immediate Activation;
- Release;
- Extinguishing;
- Release Fault;
- No Pulse Release;
- Release Inhibited.

2.16.1 The S2000-ASPT proceeds from power-off conditions to **Pre-operation** mode after mains power 220 V has been applied to the unit. In this mode the S2000-ASPT within 3 s analyses voltage from the rectifier output and then loads settings for states of inputs and outputs, the mode of automatic actuation and the operation mode from its non-volatile memory. The only indicator which illuminates is the Power indicator .

If the voltage at the AC/DC converter output (at the test point “40” on the PCB) is below 30 V or unstable, the S2000-ASPT keeps being in the **Pre-operation** mode for a not limited time until the rectifier output voltage has been a stable value higher than 30 V.

Termination of the **Pre-operation** mode is accompanied by a sound, and then the S2000-ASPT returns to an operation mode in which it was before switching off.

If before turning the power off the S2000-ASPT was in the **Release** mode, extinguishing will be aborted automatically while turning the unit on to avoid second release of the fire protection system.

2.16.2 The unit enters the **Device Failure** mode if a checksum error has been detected during a microcontroller memory test or battery charger has failed.



In case of a **checksum error**, both the Device Failure indicator  and the FAULT WARNING indicator on the front plate flash, and the internal sounder beeps.

If after a power restart of the S2000-ASPT the checksum error is detected once more, then update the microcontroller firmware by doing the following:

1. *Connect the S2000-ASPT to a PC via one of the interface converters such as an S2000M in the programming mode, PI-GR, S2000-PI, S2000-USB, or USB-RS485. Use the A1 and B1 panel terminals for connecting.*
2. *Turn the panel power on.*
3. *With the help of the program "ORION\_PROG.EXE" update the firmware.*

While the firmware is being writing the internal sounder keeps silent, the HL1 indicator on the panel PCB being lit with short breakings. When writing has been completed the unit enters the Pre-operation mode.

**Note:** The program "ORION\_PROG.EXE" and the firmware file can be downloaded from the site of the Bolid Company, <http://bolid.ru>.

If a charger failure has been detected, the indicators FAULT WARNING, , , and the internal sounder are activated in pulse mode simultaneously. In this case the Device Failure mode can be reset only by full de-energizing of the S2000-ASPT.

A charger failure can occur as a result of using damaged batteries or an overload at the 24 V output.

If after eliminating of the reasons for overloading the battery charger the S2000-ASPT enters the **Device Failure** mode then the unit should be sent to the manufacturer for repair with the relevant notification – a battery charger malfunction.

2.16.3 The S2000-ASPT is in the Quiescent mode when all its monitored circuits of the inputs and outputs are in normal conditions.

2.16.4 The S2000-ASPT enters the **Fault** mode in case of generating any message in accordance with Section 2.7.1.



When all the troubles have been repaired the unit automatically exits the **Fault** mode.

2.16.5 The S2000-ASPT enters the **Disabled** mode if at least one its input or output is disabled or disarmed or if its internal sounder is disabled. When automatic release mode is switched off, the S2000-ASPT doesn't enter the Disabled mode.

2.16.6 The **Indication Test** mode is designed for inspecting operation of light and sound indicators of the unit. To switch the S2000-ASPT to this mode, authorities of the second access level are required. Initiate the **Indication Test** mode by pressing the Test button . When the S2000-ASPT has successfully entered the Indication Test mode it plays a melody.

During testing all single-color indicators illuminate steadily while two-color indicators illuminate with red and amber alternately (see Table 2.15.1).

**Table 2.15.1**

Indicator	Color	Indicator	Color	Indicator	Color	Indicator	Color
PREALARM	Red	LOOP 1	Red/Amb*	SILENCE	Amber	 Power	Green
FIRE ALARM	Red	LOOP 2	Red/Amb*	SIREN	Red/Amb*	 On Batt.	Green
FAULT WARNING	Amber	LOOP 3	Red/Amb*	VISUAL ALARM	Red/Amb*	 Device Failure	Amber
DISABLED	Amber	CALL POINTS	Red/Amb*	FIRE	Red/Amb*		
EXTINGUISHING	Red	DOOR CIRCUIT	Amber	TROUBLE	Amber		
AUTOMATIC MODE	Amber	REMOTE COMMAND	Red/Amb*	RELEASE CIRCUIT	Red/Amb*		
TEST	Amber	DISCHARGE	Red/Amb*	AUX EQUIPMENT	Red/Amb*		
		MASS/PRESSURE	Amber	S2000-KPB	Amber		
		EXTERNAL FAULT	Amber				

\* – Illuminates with red 1 s / amber 1 s alternately.

The test of indication takes 15 s. After the test is completed the unit automatically returns to the quiescent mode.

2.16.7 The mode «**Self-Diagnostic**» is intended to inspect operation of the:

- Outputs controlling the external appliances: VA1, VA2, VA3, SA;
- FR and FLT outputs;
- NC-NO-C relay (AUX. EQUIPMENT);
- Electronic power reset key.



To start the **Self-Diagnostic** mode press the tamper switch for a short – short – short – long time (\* \* \* –).



A long press means pressing and holding the tamper switch down for at least 1.5 s. A short press means pressing and holding the tamper switch down for a time between 0.1 s and 0.5 s. A pause between presses should be between 0.1 s and 0.5 s.

The S2000-ASPT plays a melody while having entered the **Self-Diagnostic** mode.

The indicator TEST starts pulsing.

To test an output, push the relevant output's button. The condition of the output is indicated by the relevant LED: if the output is active (closed) then the LED illuminates while if the output is not active (is open) the LED is off. States of the outputs VA1, VA2, VA3, FR, FLT, NC-NO-C are switched by a next press on the button related with the output. The SA (Siren) output can be activated only for 3 s. The outputs VA1 and VA2 are pulses simultaneously.

To inspect operability of the electronic power reset key, push any of the buttons 8-«LOOP1», 9-«LOOP2», or 10-«LOOP3». While one of this button is pressed the relevant terminals «+1-», «+2-», «+3-» is de-energized for 3 s.

To leave the **Self-Diagnostic** mode push the 7-TEST button , or 5-EXTINGUISHING RESET button . The unit automatically leaves this mode after 30 s since last pushing a button.

2.16.8 The S2000-ASPT proceeds to the **On Batteries** mode in case of a failure of mains power (see Section 2.20.3).

The time when the unit is proceeding to On Batteries mode doesn't exceed 60 s since a moment of the failure. The time for the unit to be exiting the On Batteries mode doesn't exceed 300 ms since the moment of repairing mains power.

2.16.9 The S2000-ASPT enters the **Battery Fault** mode in the following situations:

- When the batteries have failed (see Section 2.20.5);

The unit enters to Battery Fault mode within:

- 4 minutes since the battery failure;

The time for the S2000-ASPT to exit the Battery Fault mode doesn't exceed:

- 4 minutes since the backup power has been restored;

The time for the unit to exit the Battery Fault mode can be decreased down to 300 ms by pushing 1-FIRE RESET button .

2.16.10 The S2000-ASPT provides controlling the *mode of automatic release of the fire extinguishing agent*.

*The mode of automatic actuation of the fire suppression system* can be enabled (if the door sensor circuit (DOOR CIRCUIT) is in normal condition and the release circuit is connected and active):

- By pushing the 3-AUTOMATIC MODE button  on the faceplate;
- By a **Switch Automatic Release Mode On** remote control command from the network controller;
- Automatically after restoring the door circuit mode (DOOR CIRCUIT) if the configuration parameter **Automatic Mode Recovery** is set on.

*The mode of automatic actuation of the fire suppression system* can be disabled:

- By pushing the 3-AUTOMATIC MODE button  on the faceplate;
- By a **Switch Automatic Release Mode Off** remote control command from the network controller;
- If the door sensor circuit is activated or failed (DOOR CIRCUIT);
- If the release circuit is disabled (see Section 2.9.7).

2.16.11 The S2000-ASPT proceeds from the Quiescent Mode to the **Prealarm** mode on receipt responses of a single fire detector in an alarm loop within 1 s and longer. If smoke active detectors are brought into the alarm loop the unit proceeds to the Prealarm mode with a repeated request of activation of the detectors (see Section 2.15.1).

The Prealarm mode can be reset by pushing 1-FIRE RESET button  or a **Reset Alarms** remote control command from the network controller.

2.16.12 The S2000-ASPT proceeds from the **Prealarm** operation mode to the **Fire Alarm** operation mode when a second detector has actuated in the same alarm loop or in another alarm loop depending on settings of the unit configuration (see Section 2.15.1).

The S2000-ASPT proceeds from the Quiescent Mode to the **Fire Alarm** mode when:

- Two or more detectors have triggered alarms in a single alarm loop or various alarm loops depending on settings of the unit configuration (see Section 2.15.1);
- A manual release station has been actuated (CALL POINTS);
- A **Release** remote control command was received from the network controller.

When the S2000-ASPT has entered the **Fire Alarm** mode its internal sounder sounds, its sound output SA (external siren) is activated and the contacts of the FR relay is closed.

The **Fire Alarm** mode can be reset by pushing 1-FIRE RESET button  or by sending a **Reset Alarms** remote command from the network controller.

2.16.13 The S2000-ASPT enters the **Pre-discharge Delay** mode when:

- A manual release station has been actuated (remote release);
- A **Release** command has been received from the network controller (remote release);
- Two automatic fire detectors have triggered alarms if *automatic release mode* is set on (automatic release).

When the S2000-ASPT has entered the **Pre-discharge Delay** mode:

- Outputs VA1 (EXIT) and SA (siren) are activated;
- The FR relay contacts are closed.

In this mode the S2000-ASPT starts counting the delay before releasing extinguishing agent (actuation of the fire suppression system). The pre-discharge delay is to be programmed individually for automatic release and remote release. Counting the time of the delay is accompanied by internal sounder's beeping. 15 s before the end of the pre-discharge delay the frequency of sound signals is doubled and within 5 s before the end of the pre-discharge delay the frequency of sound signals is four times higher. The pre-discharge delay having expired, the S2000-ASPT enters the **Release** mode.

The **Pre-discharge Delay** mode can be reset by pushing 2-EXTINGUISHING RESET button  or by sending a remote **Abort Release** command from the network controller.

2.16.14 If the S2000-ASPT operates in the **Pre-discharge Delay** mode under the S2000M panel of version 3.00 or higher and with an S2000-PT control and indicator unit of version 2.50 or higher then counting the pre-discharge delay can be stopped. Then counting of the pre-discharge delay can be continued, or the fire suppression system can be actuated immediately, or release can be aborted.

All the actions mentioned above can be performed with the help of control buttons of the S2000 -PT.

The S2000-ASPT can proceed from the **Pre-discharge Delay** mode to the following modes:

- **Pre-discharge Time Hold;**
- **Immediate Activation;**
- **Release Inhibited;**
- **Release.**

Release can be aborted by pushing 2-EXTINGUISHING RESET button  or by a remote **Abort Release** command from the network controller.

Counting down of the time remaining before release is displayed by S2000-PT of versions 2.50+ and S2000M of versions 3.00+.

2.16.15 The modes **Pre-discharge Time Hold** and **Immediate Activation** are initiated on receiving relevant commands from the network controller.

2.16.16 In the **Pre-discharge Time Hold** mode counting of the pre-discharge delay has been stopped. The unit can return to the **Pre-discharge Delay** mode on receiving a relevant command from the network controller. In this case counting the pre-discharge delay will be continued.

The unit can proceed from the Pre-discharge Time Hold mode to the Release Inhibited mode (see Section 2.16.18 and Section 2.16.20).

The Pre-discharge Time Hold mode can be reset by pushing 2-EXTINGUISHING RESET button  or by a remote **Abort Release** command from the network controller.

2.16.17 When the S2000-ASPT has entered the **Immediate Activation** mode, it sets the delay to zero and enters the **Release** mode immediately.

2.16.18 In case of automatic activation (when two or more automated fire detectors has tripped) the S2000-ASPT enters the **Release Inhibited** mode if:

- The door sensor circuit is activated or faulted (DOOR CIRCUIT);
- If *automatic release mode* is disabled;
- The release circuit is disabled (see Section 2.9.7).

*Automatic release mode* can be disabled by:

- Pushing the button  (AUTOMATIC MODE) on the S2000-ASPT faceplate;
- Sending a **Switch Automatic Release Mode Off** command from the network controller.

When the door sensor circuit (DOOR CIRCUIT) is activated or faulty as well as when the release circuit is disabled, *automatic release mode* switches off.

In the **Release Inhibited** mode counting of the pre-discharge delay is stopped. The S2000-ASPT can return to the **Pre-discharge Delay** mode (counting of the pre-discharge delay will be restarted from its initial value), or to the **Pre-discharge Time Hold** mode if *all* of the following conditions are true:

- The configuration parameter **Automatic Release Recovery** is set on;
- *Automatic release mode* is switched on;
- The door sensor circuit (DOOR CIRCUIT) is repaired and recovered;
- The release circuit is enabled.

Restoring of the door sensor circuit (DOOR CIRCUIT) and connecting of the release circuit are the mandatory requirements for *automatic release mode* to be switched on.

*Automatic release mode* can be switched:

- By pushing 3-AUTOMATIC MODE button  on the unit's faceplate;
- By a remote **Switch Automatic Release Mode On** command from the network controller;
- Automatically after recovering the door sensor circuit (DOOR CIRCUIT) if the configuration parameter **Automatic Mode Recovery** is set on.

If the S2000-ASPT is in the **Release Inhibited** mode and automatic release is enabled the unit can enter the **Pre-discharge Delay** mode again when:

- A manual call point has been activated;
- A **Release** command has been received from the network controller.

2.16.19 If the automatic release mode is switched off, the S2000-ASPT switches on the visual alarm 3, AUTOMATICS OFF light sign.

2.16.20 In case of remote activation (when the manual release station is actuated or a **Release** command has been received from the network controller) the S2000-ASPT can enter the **Release Inhibited** mode if **all** the following conditions are true:

- The configuration parameter **Remote Release Priority** is set off;
- The door sensor circuit (DOOR CIRCUIT) is activated or faulty.

In this case counting of the pre-discharge delay is stopped. If the door circuit has been recovered the S2000-ASPT enters the **Pre-discharge Delay** mode (provided that counting the pre-discharge delay is started again from the beginning) or returns to the **Pre-discharge Time Hold** mode.

2.16.21 If the configuration parameter **Remote Release Priority** is set on then the counting of the pre-discharge delay for remote release (after actuation of a manual release station or on receiving a **Release** command from the network controller) is not stopped and the unit doesn't enter the **Release Inhibited** mode. At the end of the pre-discharge time the S2000-ASPT switches to the **Release** mode.

2.16.22 When the S2000-ASPT enters the **Release** mode, it switches the *automatic release mode* off, generates a release pulse of a given duration at the output of the release circuit R, and gives a command to activate the connected S2000-KPB units. The external visual alarm VA1 (EXIT) is switched off while the external visual alarm VA2 (KEEP OUT) pulses.

The **Release** mode can be reset by pushing 2-EXTINGUISHING RESET button  or by a remote **Abort Release** command from the network controller.

2.16.23 If the release circuit is disabled (see Section 2.9.7) then no command to activate the connected S2000-KPB is given.

2.16.24 If within the duration of a release pulse the pressure detector brought to the pressure detector circuit has responded then at the end of the **Release** mode the S2000-ASPT switches to the **Extinguishing** mode (successful activation).

If the configuration parameter **Disable Monitoring for Pressure Detector** is set on then at the end of the **Release** mode the S2000-ASPT immediately switches to the **Extinguishing** mode.

The **Extinguishing** mode can be reset by pushing 2-EXTINGUISHING RESET button  or by a remote **Abort Release** command from the network controller.

2.16.25 If no response from the pressure detector has been detected within duration of a release pulse then the S2000-ASPT proceeds from the **Release** mode to **Release Fault** mode.

The unit will proceed from the **Release Fault** mode to the **Extinguishing** mode if the signal device has triggered in the pressure detector circuit.

The **Release Fault** mode can be reset by pushing 2-EXTINGUISHING RESET button  or by a remote **Abort Release** command from the network controller.

2.16.26 The S2000-ASPT proceeds from the Quiescent mode to the No Pulse Release mode in case of triggering pressure detectors connected into the pressure detector circuit.

In the **No Pulse Release** mode:

- Outputs VA1, VA2, SO are activated;
- The contacts of the FLT relay are closed.

In the **No Pulse Release** mode the S2000-ASPT generates no release pulse and gives no release commands to connected S2000-KPB units.

The **No Pulse Release** mode can be reset by pushing 2-EXTINGUISHING RESET button  or by sending a remote **Abort Release** command from the network controller.

2.17 Indication of the S2000-ASPT is described in Tables 2.16 – 2.32.

**Table 2.16** Prealarm Indicator

<b>S2000-ASPT Mode</b>	<b>Indicator Performance</b>
Fire Prealarm	Pulses once per second with 0.5 s on and 0.5 s off
Others	Off

**Table 2.17** Fire Alarm Indicator

<b>S2000-ASPT Mode</b>	<b>Indicator Performance</b>
Fire Alarm	On
Others	Off

**Table 2.18** Fault Warning Indicator

<b>S2000-ASPT Mode</b>	<b>Indicator Performance</b>
Fault	Pulses once per 2 seconds with 1 s on and 1 s off
Disabled (except for disabled internal sounder)	
Device Failure	
No Pulse Release	
Tamper Alarm	
Others	Off

**Table 2.19** Disabled Indicator  
Silence Indicator

<b>S2000-ASPT Mode</b>	<b>Indicator Performance</b>
Disabled (including disabled internal sounder)	On
Others	Off

**Table 2.20** Extinguishing Indicator

<b>S2000-ASPT Mode</b>	<b>Indicator Performance</b>
Pre-discharge Delay	Pulses once per second with 0.5 s on and 0.5 s off
Pre-discharge Time Hold	
Release	Pulses twice per second with 0.25 s on and 0.25 s off
Release Fault	
Extinguishing	
Others	Off

**Table 2.21** Automatic Mode LED

<b>Automatic Release Mode</b>	<b>Indicator Performance</b>
On	Off
Off	On

**Table 2.22** Test LED

<b>S2000-ASPT Mode</b>	<b>Table Performance</b>
Indication Test	On
Self-Diagnostic	Pulses twice per second with 0.25 s on and 0.25 s off
Others	Off

**Table 2.23** Loop 1 Indicator  
Loop 2 Indicator  
Loop 3 Indicator

Input Status	Indicator Performance	Color
OK	Off	–
Fire Signal	Double short pulses for 0.125 s once per two seconds	Red
Fire Pre-alarm	Pulses once per second with 0.5 s on and 0.5 s off	Red
Fire Alarm	On	Red
Short Circuit, Open Circuit	Pulses once per two seconds with 1 s on and 1 s off	Amber
Arming Failed	Pulses once per two seconds with 0.5 s on / 1.5 s off	Amber
Disabled	On	Amber

**Table 2.24** Call Points Indicator  
Remote Command Indicator

Input Status	Indicator Performance	Color
OK	Off	–
Fire Alarm	Pulses twice per second with 0.25 s on and 0.25 s off	Red
Short Circuit, Open Circuit*	Pulses once per two seconds with 1 s on and 1 s off	Amber
Arming Failed*	Pulses once per two seconds with 0.5 s and 1.5 s off	Amber
Disabled	On	Amber

\* - For Call Points indicator

**Table 2.25** Door Circuit Indicator  
External Fault Indicator

Input Conditions	Indicator Performance
OK	Off
Activation	Pulses once per second: 0.5 s on and 0.5 s off
Short Circuit, Open Circuit	Pulses with 1 s on and 1 s off (once per 2 seconds)

**Table 2.26** Discharge Indicator

Input Conditions	Indicator Performance	Color
OK	Off	–
Activation	Pulses once per second: 0.5 s on and 0.5 s off	Red
Short Circuit, Open Circuit	Pulses with 1 s on and 1 s off (once per 2 seconds)	Amber
Arming Failed	Pulses once per 2 seconds with 0.5 s on and 1.5 s off	Amber
Disabled	On	Amber

**Table 2.27** Mass/Pressure Indicator

Input Conditions	Indicator Performance
OK	Off
Activation of Mass or Pressure input of any of the slave S2000-KPB	Pulses with 1 s on and 1 s off (once per 2 seconds)

**Table 2.28** Siren Indicator  
 Visual Alarms Indicator  
 Fire Output Indicator  
 Release Circuit Indicator  
 Auxiliary Equipment Indicator

Output Conditions	Indicator Performance	Color
Off	Off	–
On	On	Red
Short Circuit, Open Circuit	Pulses with 1 s on and 1 s off (once per 2 seconds)	Amber
Disabled	On	Amber



**Table 2.29** Trouble Output Indicator

Output Conditions	Indicator Performance
On	Off
Off	
Disabled	On

**Table 2.30** S2000-KPB Indicator

Output Conditions	Indicator Performance
Loss of communication with one of the slave S2000-KPB (if available)	Pulses once per 2 seconds: on for 1 s / off for 1 s
Tamper alarm of a slave S2000-KPB	
Power failure of a slave S2000-KPB	
Short/Open failure of an output circuit of a slave S2000-KPB	
Others	Off

**Table 2.31** Power Indicator  
 On Batteries Indicator

S2000-ASPT Mode	Indicator Performance	
		
Quiescent mode	On	On*
On Batteries (mains power failed, backup power is OK)	Pulses twice per second with 1 s on and 1 s off	On*
Battery Fault (mains power is OK, backup power failed)	On	Pulses twice per second with 1 s on and 1 s off
Power failure (both mains and backup power failed)	Pulses twice per second with 1 s on and 1 s off	Pulses twice per second with 1 s on and 1 s off
De-energized	Off	Off

\* – When units of some earlier versions are updated to the version 3.51 this indicator shows amber light. In this case when the backup battery fails the indicator pulses while if the battery is OK the indicator is off.

**Table 2.32** Device Failure Indicator

S2000-ASPT Mode	 Indicator Performance
Device Failure	On for 1 s and off for 1 s (0.5 Hz)
Others	Off

2.18 Indication of external sound alarm and external visual alarms of the S2000-ASPT is described in Tables 2.33 – 2.38.

**Table 2.33** External Sound Alarm – Siren

S2000-ASPT Mode	Siren Performance
Fire Alarm, Pre-discharge Delay, Pre-discharge Time Hold, Release Inhibited, Release, Extinguishing, No Pulse Release, Release Fault	1.5 s on /0.5 s off* (On)**
Others	Off

\* - Continuous operation of SA (Siren) is set off

\*\* - Continuous operation of SA (Siren) is set on

**Table 2.34** Visual Alarm 1 – EXIT

S2000-ASPT Mode	Alarm Performance
Pre-discharge Delay, Pre-discharge Time Hold, Release Inhibited, No Pulse Release	0.5 s on /0.5 s off* (On)**
Release, Extinguishing	Off
Others	Off

\* - Continuous operation of VA1 (EXIT) is set off

\*\* - Continuous operation of VA1 (EXIT) is set on

**Table 2.35** Visual Alarm 2 – KEEP OUT

S2000-ASPT Mode	Alarm Performance
Fire Alarm, Pre-discharge Delay, Pre-discharge Time Hold, Release Inhibited	Off
Release, Extinguishing, Release Fault, No Pulse Release	0.5 s on / 0.5 s off* On**
Others	Off

\* - Continuous operation of VA2 (KEEP OUT) is set off

\*\* - Continuous operation of VA2 (KEEP OUT) is set on

**Table 2.36** Visual Alarm 3 – AUTOMATICS OFF

Automatic Release Mode Option	Alarm Performance
Enabled	Off
Disabled	On

**Table 2.37** Trouble Relay

S2000-ASPT Mode	Contacts Are
De-energized, Fault, Disabled, Tamper Alarm	Open
Others	Closed

**Table 2.38** Fire Relay

S2000-ASPT Mode	Contacts Are
Fire Alarm, Pre-discharge Delay, Pre-discharge Time Hold, Release, Release Inhibited, Extinguishing, Release Fault	Closed
Others	Open



2.19 The S2000-ASPT provides connecting the network controller to its RS-485-1 interface port and slave S2000-KPB units to its RS-485-2 interface port.

2.19.1 The S2000-ASPT provides implementation of the following commands received from the network controller over the RS-485-1 interface:

- Write a configuration;
- Read the configuration;
- Assign a network address;
- Reset alarms;
- Hold the pre-discharge delay;
- Immediate release;
- Abort release;
- Release extinguishing agent;
- Switch automatic release mode on and off;
- Synchronization;
- Request for input and output states (including states of input and outputs of the connected S2000-KPB).

2.19.2 The S2000-ASPT provides receiving the following messages from the S2000-KPB units over the RS-485-2:

- Device Reset;
- Tamper Alarm;
- Tamper Restored;
- Power Failure (the input number being specified);
- Power Restored (the input number being specified);
- Input Short Circuit;
- Input Open Circuit;
- AC Power Failure;
- AC Power Restored;
- Auxiliary Zone Alarm;
- Auxiliary Zone Alarm 2;
- Auxiliary Zone Restored;
- Fire Equipment Trouble;
- Fire Equipment Restored;
- Low Level;
- Two Low Level;
- High Level;
- Too High Level;
- Normal Level;
- Pump On;
- Pump Off;
- Battery Failed;
- Battery Restored;
- Output Short Circuit;
- Output Open Circuit;
- Output Repaired;
- Change of Output Status.

2.19.3 The S2000-ASPT provides transmitting a release (abort release) command over the RS-485-2 interface to each S2000-KPB specified in the S2000-ASPT configuration.

2.19.4 The S2000-ASPT provides requesting for states of all inputs, outputs, power inputs and tamper switches of all the S2000-KPB units specified in the S2000-ASPT configuration.

2.19.5 Connecting terminating resistors into each of interface buses RS485-1 and RS-485-2 is performed by means of closing XP1 and XP2 jumpers respectively (see Table 2.39).

Table 2.39

Jumper	Position	Interface Bus Condition
XP1, XP2	Closed	The termination resistance is connected. (The S2000-ASPT is at one of the far ends of the RS-485 interface bus.)
	Open	The termination resistance is disabled. (The S2000-ASPT is not an end device in the RS-485 interface bus)

## 2.20 Power.

2.20.1 The S2000-ASPT remains functional while being supplied by a mains power 130 V to 250 V and (50±1) Hz.

2.20.2 The S2000-ASPT remains functional while being supplied by a backup power supply 22 V to 28 V.

Two batteries of 12 V and capacity (4...4.5) Ah are used as a backup power supply.

### **WARNING: Do not operate the S2000-ASPT without connected batteries**

2.20.3 The S2000-ASPT sends an AC Power Failed message if:

- The mains power voltage has dropped below 130±10 V;
- The voltage at the output of the rectifier (the test point «40») has dropped below 30±0.5 V.

The trouble message is sent within 60s since the failure has occurred.

The S2000-ASPT sends an AC Power Restored message if:

- The mains power voltage has exceeded 180±10 V;
- The voltage at the output of the rectifier (the test point «40») has exceeded 40±0.5 V.

2.20.4 If the mains power failed the S2000-ASPT automatically begins to consume power from the backup batteries. The mains power having been applied, the S2000-ASPT returns to being powered by mains.

2.20.5 The S2000-ASPT generates a Power Failed message within four minutes since the battery voltage has dropped below 22±0.5 V under test current load (0.5 A in quiescent mode).

The S2000-ASPT sends a Battery Restored message when the battery voltage exceeds 25±0.5 V.

2.20.6 If mains power failed and the battery voltage has dropped below 20.5±0.5 V (full discharge) the S2000-ASPT disconnects itself from the power.

2.20.7 The power consumed by the S2000-ASPT from the mains power supply doesn't exceed 30 V\*A.

2.20.8 The procedures of evaluating of the current consumed by the S2000-ASPT from the backup power supply in the Quiescent mode and the Fire Alarm mode are described in Appendix F.

2.21 The S2000-ASPT remains functional and doesn't issue false alarms to external circuits under exposure to electromagnetic interference of the second severity level and below in accordance with Russian Standard ГOCT P 50009.

Short-duration (no longer than 2 s) disturbance in indication on the faceplate at the moment of an electromagnetic pulse is acceptable.

2.22 RFI of the S2000-ASPT meets the requirements of Russian Standard ГOCT P 50009.

2.23 The pre-operation time of the S2000-ASPT after powering up doesn't exceed 10 s.

2.24 Operating conditions are the following:

- The relative humidity up to 98% at 298 K (+25 °C);
- Vibration loads in the frequency range from 1 to 35 Hz at maximum acceleration of 0.5 g.

2.24.1 Operating Temperatures:

- 273 K to 323 K (0 °C to +50 °C) if backup batteries are within the S2000-ASPT;
- 243 K to 323 K (minus 30 °C to +50 °C) if the backup batteries are located apart from the S2000-ASPT.

2.25 The mean time between failures is at least 40,000 hours.

2.26 The average lifespan of the S2000-ASPT is 10 years.

The backup batteries used with the S2000-ASPT must be replaced not less than once in 5 years. Do not replace just one battery if two batteries were in use.

2.27 The overall dimensions of the S2000-ASPT are 305 mm × 255 mm × 95 mm max.

2.28 The weight of the S2000-ASPT doesn't exceed 6 kg (without backup batteries).

### **3 Standard Delivery**

Following is the list of the S2000-ASPT components provided:

- ✓ The S2000-ASPT Fire Alarm and Extinguishing Control Unit
- ✓ This Engineer's and User's Manual
- ✓ The component parts including:
  - 7 termination resistors MF 1/2W-4K7-5%
  - 5 load connection modules
  - 1 AC fuse 0.5 amp
  - 2 mechanical lock keys
  - 2 electric-contact lock keys
  - 1 battery connector
  - 3 woodscrews
  - 3 wall plugs 8×35
  - 2 plastic bushings

***Notes:***

1. The S2000-ASPT is delivered WITHOUT backup batteries.
2. Batteries 12 V, 4.5 Ah can be delivered under a particular contract.

## **4 Marking**

4.1 Each S2000-ASPT is marked by a:

- Manufacturer logo;
- Identification mark;
- Two last digits of the year and the quarter when the unit was made;
- Conformity mark;
- Factory number.

4.2 The external terminals of the S2000-ASPT are marked in accordance with its connection diagram.

4.3 Near the mains-operating socket there is the lettering denoting the rated voltage of the mains power supply.

4.4 There is a protective ground terminal on the S2000-ASPT cabinet.

## **5 Packing**

5.1 The unit is packaged in a consumer container - a cardboard box containing component parts and operating documentation for the unit.

5.2 The units can be packed to containers in accordance with Russian Standard ГOCT 9181-74.

5.3 Conservation of the units should be made in accordance with Russian Standard ГOCT 9.014-78 for a group of products III-3 with a variant of temporary anti-corrosion protection VZ-0.

5.4 Boxes with packed units, the list of component parts, and the component parts for packed units are placed in a shipped container – a box of the type II-I in accordance with Russian standard ГOCT 5959-80.

5.5 A packing list with the following information must be placed in each box or container:

- 1) The trademark of the manufacturer;
- 2) The number and the name of the units;
- 3) Designation and the number of the component parts;
- 4) The signature or stamp of a person responsible for packaging;
- 5) The day of packaging.

## **6 Operating Instructions**

6.1 To ensure the declared characteristics, the unit should be operated with connected and charged batteries.

6.2 Having the unit unpacked, please:

- Inspect the unit visually and ensure that it is not damaged;
- Check the delivery set of the unit.

6.3 Prior to applying power to the S2000-ASPT after transportation the unit should be kept unpacked in normal conditions for at least 24 hours.

## **7 Safety Precautions**

7.1 While installing and operating the S2000-ASPT please follow your local applicable electric codes, standards, regulations and ordinances.

7.2 Only the persons must be permitted to mount, install, inspect and maintain the unit who have a relevant electrical safety qualification level and is skilled to operate with 1000 V voltage.

7.3 Do not use fuses of another value than the nominal one and do not operate the unit without grounding.

7.4 Always do shut off mains and backup power of the S2000-ASPT prior to mounting and troubleshooting.

7.5 Operating the unit please take into account that the terminals “~220 V” can be live and dangerous.

## 8 Design of the S2000-ASPT

8.1 Design of the S2000-ASPT provides its operations if it is installed on a wall.

8.2 The main design elements of the unit are (see Appendix A *Design of the S2000-ASPT*):

- The control board – 1;
- The main PCB – 2;
- The tamper switch – 3;
- The F1 fuse holder – 4;
- The power and ground terminal block – 5;
- The transformer – 6;
- The cabinet – 7;
- The cabinet's door – 8;
- The faceplate – 9;
- The key switch – 10;
- The mechanical lock – 11;
- The battery leads – 12;
- The backup batteries in assembly (2 batteries) – 13.

8.3 The following elements are on the main PCB:

- Terminal blocks:
  - «+1-», «+2-», «+3-»: For connecting alarm loops LOOP1, LOOP2, and LOOP3;
  - «+4-»: For connecting the door position sensor circuit (DOOR CIRCUIT);
  - «+5-»: For connecting manual release stations (CALL POINTS);
  - «+6-»: For connecting the pressure detector circuit (DISCHARGE);
  - «+7-»: For connecting a fire equipment fault signal device (EXTERNAL FAULT);
  - «FLT»: The output for sending troubles to the central station;
  - «FR»: The output for sending fire alarms to the fire brigade (central monitoring station);
  - «NO-NC-COM»: The relay output to control utility equipment;
  - «+24V-»: The output of the 24 V power supply;
  - «0V»: The output of the «0V» circuit of the S2000-ASPT;
  - «A1», «B1»: For connecting the RS-485-1 interface line;
  - «A2», «B2»: For connecting the RS-485-2 interface line;
  - «-R+»: The pyro device circuit (release circuit);
  - «-VA1+»: For connecting a visual alarm 1 (VA1) – «EXIT» light sign;
  - «-VA2+»: For connecting a visual alarm 2 (VA2) – «KEEP OUT» light sign;
  - «-VA3+»: For connecting a visual alarm 3 (VA3) – «AUTOMATICS OFF» light sign;
  - «-SA+»: For connecting a sound alarm (SA) – a siren;
- Jumpers:
  - XP1: For connecting the match resistor to the RS-485-1 interface line;
  - XP2: For connecting the match resistor to the RS-485-2 interface line;
- LEDs;
- Voltage test points:
  - «0» – 0V circuit of the S2000-ASPT;
  - «5» – (5±0,5) V voltage-stabilized output;
  - «27» – (27±0,5) V voltage-stabilized output;
  - «40» – Mains rectifier voltage.

8.4 A tamper switch which senses opening the S2000-ASPT is situated on the side of the cabinet base behind the door of the cabinet. The tamper switch is connected to the terminal XP1 of the main PC board with the help of a two-strand cable. When the door of the cabinet is closed the tamper switch contact is closed.

8.5 The locations of buttons and indicators are specified on the faceplate 9.

8.6 For attaching the unit to a vertical surface, there are three holes on the rear wall of the cabinet 7 to hang the unit on the screws and one hole to fix the unit with a screw. The mounting dimensions of the S2000-ASPT are shown in Appendix A.

## 9 Installation Procedure

9.1 The S2000-ASPT is supplied by the manufacturer in following conditions:

- Backup batteries are not installed;
- XP1 and XP2 jumpers are closed;
- The tamper switch is connected;
- The configuration parameters are as shown in Tables 2.12– 2.15.

9.2 To change the default settings of the configuration parameters do the following.

9.2.1 Connect the S2000-ASPT to a personal computer via one of the interface converters S2000M in programming mode, PI-GR, S2000-PI, S2000-USB, or USB-RS485. Use terminals A1 and B1 of the S2000-ASPT for connecting.

9.2.2 Connect a backup battery to the S2000-ASPT. Connect the S2000-ASPT to the mains. Wait until the Pre-operation mode has completed.

9.2.3 Run **Uprog.exe**. Specify the proper COM port of the computer and start the procedure of searching devices.

**Note:** The last version of **Uprog.exe** can be downloaded from the site of the Bolid Company at the address of <http://bolid.ru>.

9.2.4 Wait until the software utility has found the connected S2000-ASPT and select it in the list of the found devices (if several units are connected).

9.2.5 Change configuration parameters using the program interface. Write configuration into the unit memory and if necessary change the network address of the unit by means of the relevant menu commands.

9.2.6 If an S2000M panel is used to change the network address of the unit, perform the following.

9.2.6.1 Wait until the panel shows a message about connecting a new unit.

9.2.6.2 Press PROG key on the panel. Enter the password and select the Addresses menu.

Specify the current address of the unit. Then specify a new address of the unit and press ENTER. If the new address is assigned successfully the panel responds with two beeps.

9.2.7 When the S2000-ASPT is connected to the network of an Orion Integrated Security System or when several S2000-KPB units are connected to the RS-485-2 port of the S2000-ASPT IT IS PROHIBITED TO ASSIGN A NETWORK ADDRESS TO TWO OR MORE VARIOUS DEVICES. Connect the units to the interface line one-by-one assigning a new, unique network address to each one. When you disconnect the S2000-ASPT from the interface line RS-485-1 or RS-485-2 DO NOT DISCONNECT ONLY ONE WIRE OF THE INTERFACE LINE FROM THE UNIT. ALWAYS DISCONNECT BOTH THE WIRES.

9.3 Connect the unit terminals with the external circuits as shown in Appendix B.

9.3.1 Connect alarm loops to the terminals «+1-»...«+3-». Connection diagrams for connecting detectors are shown in Appendix C. The number of the detectors that can be brought in a single alarm loop can be estimated as discussed in Section 2.12.1.7.

If an alarm loop is not in use connect one of the termination resistors provided MF 1/2W-4K7-5% across the contacts of the alarm loop input.

9.3.2 The terminals «+4-», «+6-», «+7-» are connected with the door sensor circuit, the pressure detector circuit, and fire equipment fault circuit respectively.

Any contact detectors or relay outputs of other alarm system devices can be used as condition sensors or signal devices. The diagrams for connecting the detectors are shown in Appendix C. The number of detectors, state circuits or signaling devices not powered by a circuit is not limited.

If this circuit is not in use, connect the supplied MF 1/2W-4K7-5% termination resistor across the relevant terminals.

9.3.3 The terminals «+5-» are connected with the manual release station circuit. Any manual release stations suitable for cooperation with a device with a constant voltage at the loop can be used. The schematic for connecting the call points is shown in Appendix C.

If this circuit is not in use, connect the supplied MF 1/2W-4K7-5% termination resistor across the relevant terminals.

9.3.4 The terminals VA1, VA2, VA3, SA are connected with light and sound alarms. The parameters and destination of outputs for connecting alarms are shown in Table 2.1. The schematic for connecting alarms (notification appliances) is shown in Appendix B.

**DO NOT CONNECT A RATED LOADING TO THE OUTPUTS IF BACKUP BATTERIES ARE NOT CONNECTED.**

**LOAD CONNECTION MODULES WHICH ENABLES THE S2000-ASPT TO MONITOR OUTPUT CIRCUIT CONDITIONS SHALL BE INSTALLED CLOSELY TO A LIGHT OR SOUND ALARM.**

**WHILE COMMISSIONING OR IF AN OUTPUT IS NOT IN USE CONNECT A 1W-1K RESISTOR ACROSS THE RELEVANT TERMINALS.**

9.3.5 The release circuit is connected to the “R” terminals of the S2000-ASPT. The parameters of the output for connecting the release circuits are shown in Table 2.1. If a releasing device imposes any additional limitation on the value of current then connect a suitable current limiting resistor in series with the releasing device.

The resistance value of a current limiting resistor  $R_{lim}$  can be estimated using the formula below:

$$R_{lim} = \frac{20}{I_{tr}} - (R_{wires} + R_{br}), \text{ [ohms], where:}$$

$I_{tr}$  stands for the required trip current, [A]

$R_{wires}$  stands for the resistance of wires between the S2000-ASPT and the fixed fire extinguishing system, [ohms];

$R_{br}$  stands for the average effective resistance of the fusehead (resistance bridge), [ohm].

Finally, the nearest lesser E24 preferred value is selected as the standard value for the current limiting resistor.

The expected value of dissipated power rating  $W_{lim}$  can be found using the formula:

$$W_{lim} = \left( \frac{27}{R_{br} + R_{wires} + R_{lim}} \right)^2 * R_{ozp}, \text{ [W].}$$

The power rating of the selected resistor must exceed the calculated expected value.

9.3.6 Connect terminals «A1» and «B1» with the interface line RS-485-1 for cooperation with the network controller. The connection diagram is presented in Appendix D.

9.3.7 Connect terminals «A2» and «B2» with the interface line RS-485-2 for cooperation with the slave S2000-KPB units. The connection diagram is presented in Appendix D.

9.3.8 If necessary, connect circuits for sending fire alarms and troubles to a fire brigade (or central monitoring station) to the FR and FLT terminals.

A fire alarm message is sent by closing the FR relay contacts while a trouble message is sent when the FLT relay contacts are open.

9.3.9 The terminals «NO-NC-COM» (the contacts «NO» – «COM» are normally open while the contacts «NC» – «COM» are normally closed) should be connected when necessary to control technological and engineer equipment (HVAC systems, smoke removal systems, air locks, fire dampers, door closing devices and so on). The parameters of the outputs are shown in Table 2.1.

9.4 Close the door of the S2000-ASPT and turn the key switch on the unit front plate to the Locked position .

## 10 Preparation for Work

10.1 Prior to putting the S2000-ASPT into operation consider all control and indication elements of the unit and technical characteristics of the unit.

10.2 Before the first operating of the unit you are recommended to test its operability by doing the following:

- 1) Arrange the test connections as shown in Appendix E.

2) Connect the terminals «A1-B1» of the tested S2000-ASPT with the interface bus from the S2000M panel.

3) Insert the backup batteries and connect the unit to the mains.

4) After being in the Pre-operation mode the S2000-ASPT shall proceed to the Quiescent mode, the S2000M displaying the messages “CONNECTED D127” and “DEVICE RESTART D127”.

5) Turn the key switch on the unit front plate to the Unlocked position .

If the S2000-ASPT operates in one of the alarm modes press the Fire Reset or Extinguishing Reset button to switch the unit to the Quiescent mode.

If the AUTOMATIC MODE indicator is turned on reset it by pressing the relevant button. The indicator H8 shall start lighting.

6) Press and hold down the button S1. The H1 indicator shall go out for 3 s while the LOOP 2 indicator shall flash with red. The S2000M shall display the message “FIRE SIGNAL 127/002”.

In 2 s after the indicator H1 has turned on again the S2000-ASPT shall enter the Fire Pre-alarm mode, the S2000M displaying the message “FIRE PREALARM 127/002”. Then the H4 indicator shall start lighting.

7) Release the button S1 and press down the button S2. The LOOP 3 indicator shall start pulsing, the S2000M displaying the message “FIRE SIGNAL 127/003” followed by the “FIRE PREALARM 127/003” message. Release the button S2.

8) In 2 s the S2000-ASPT enters the Fire Alarm mode, the S2000M displaying “FIRE ALARM 127/010”.

The H3 indicator shall show solid light while the H9 indicator shall pulse.

9) Press the AUTOMATIC MODE button on the panel front plate. The automatic release mode shall be turned on and the panel shall enter the Pre-discharge Delay mode. The S2000M shall display the message “AUTOMATICS ON 127/009” followed by the message “PREDISCHARGE DELAY 127/010”.

The H8 indicator shall switch off while the H6 indicator shall pulse.

10) Couple shortly the contacts «+4-» of the door sensor circuit. The S2000-ASPT shall enter the Release Inhibited mode, the S2000M displaying the messages “LOOP TRBL SHORT 127/004”, “RELEASE INHIBITED 127/010”, and “EX MODE MANUAL 127/009” sequentially. Both the H2 and H8 indicators shall switch off.

11) Recover the door sensor circuit. The S2000M shall display “AUX ZONE RESTORE 127/004”, the H2 indicator starting lighting in 2 s.

12) Switch the automatic release mode on again repeating all the actions from the Step 9). The S2000-ASPT shall enter the Pre-discharge mode again. The S2000M shall display the messages “EX MODE AUTO 127/009” and “PREDISCHARGE DELAY 127/010”. In 30 s the S2000-ASPT shall enter the Release mode; the H5 indicator shall switch on while the automatic release mode shall switch off. The S2000M shall display the messages “RELEASE 127/010” and “EX MODE MANUAL 127/009”.

The H6 indicator shall go out while the H7 indicator shall start flashing.

13) In 15 s the indicator H5 shall go out, the S2000M displaying the message “RELEASE FAULT 127/010”.

*Note: The Release Fault message was generated because no response from the pressure detector had been detected during the release pulse.*

14) Press the Extinguishing RESET button and then press the Fire RESET button. The S2000-ASPT shall enter the Quiescent mode. The S2000M shall sequentially display the messages “CANCEL RELEASE 127/010”, “ALARM RESET LP 127/002”, “ALARM RESET LP 127/003”, “ARMED LP 127/010”, “ARMED LP 127/002”, and “ARMED LP 127/003”.

15) Disconnect the S2000-ASPT from the mains power by removing the F1 holder. Within a minute the S2000-ASPT shall enter the On Batteries mode. In the process of entering this mode the H2 indicator shall turn off, the S2000M displaying the message “AC POWER FAILED 127/007”.



16) Restore the mains power for the S2000-ASPT. The unit shall return the Quiescent mode, the S2000M displaying “AC POWER RESTORED 127/007”.

17) Separate the red wire from the backup battery. Within 15 minutes the S2000-ASPT shall proceed to the Battery Fault mode. In this process the H2 indicator shall switch off, the S2000M displaying the message “BATTERY FAILED 127/008”.

18) Reconnect the red wire to the battery. Wait for 15 minutes or push the Fire RESET button. The S2000-ASPT shall return to the Quiescent mode, the S2000M displaying the message “BATTERY RESTORED 127/008”.

19) Disconnect the backup batteries and the mains power. Close the S2000-ASPT door and turn the key switch to Locked position .

## **11 Performance**

11.1 Only the persons can be accessed to operate the S2000-ASPT who have studied this Engineer’s and User’s Manual and S2000M User’s Manual as well as instruction manuals for S2000-KPB units and S2000-PT modules (in case of cooperation with the devices in question).

11.2 The main operation modes of the S2000-ASPT are discussed in Sections 2.16, 2.17.

11.3 Following are described operation of the S2000-ASPT as part of an Orion system.

11.3.1 Arrangement of fire suppression control systems is shown in Appendix D.





11.3.2 The number of release outputs can vary from 1 to 97 depending on the number of connected S2000-KPB units (up to 16 ones). The addresses of S2000-KPB connected to the RS-485-2 port of the S2000-ASPT can be the same as some addresses of the devices connected to the RS-485-1 port of the S2000-ASPT. The numbers of the S2000-KPB used to increase the number of release circuits must be specified in the S2000-ASPT configuration.

11.3.3 Remote control and monitoring conditions of the S2000-ASPT can be implemented with the help of S2000-PT Control and Indicator Module. For doing so the network controller shall be programmed appropriately.

## 12 Troubleshooting

12.1 Use Table 12.1 to resolve minor S2000-ASPT installation and operation problems.

**Table 12.1** Resolving Problems

Problem	Possible Cause	Solution
1) Being connected to the mains power 220 V, the unit is not operational. The indicators on the faceplate are switched off	No utility voltage or F1 fuse is out of service	Check the S2000-ASPT power supply connection. Replace the fuse
2) Being disconnected from the mains power 220 V the unit switches off while being connected to the mains power the unit indicates the battery fault conditions	Contact impairment between battery leads and terminals. The battery is inoperable or discharged	Check the contacts. Measure the voltage of each battery (should be at least 12 V). Charge or replace the battery
3) The indicator on the PCB pulses rapidly. The indicators on the faceplate are off	The cord to couple the main PCB and the indication PCB is disconnected or defective	Connect the cable. Check the connection
4) The FAULT WARNING indicator pulses while the unit sounder is silent	The tamper switch has been open or out of service	Check connection of the tamper switch. When the unit door is closed the plunger must be pushed within 15 s
5) On powering up the indicators FAULT WARNING and  pulse for a long time (longer than 10 s). The sounder is silent	The S2000-ASPT is in the Pre-operation mode. The mains power voltage is below the normal range	Check the mains power voltage at the power input of the S2000-ASPT and at the output of the rectifier (test point «40»)
6) After applying power to the S2000-ASPT the indicators FAULT WARNING and  pulse; the internal sounder pulses, the indicator on the unit's PCB flashes rapidly	Microcontroller firmware has failed, the S2000-ASPT has entered the Device Failure mode	Update the firmware of the microcontroller (see Section 2.16.2)
7) After applying power to the S2000-ASPT the indicators FAULT WARNING,  and  pulse; the internal sounder pulses	A battery charger failure has been detected, the S2000-ASPT is in the Device Failure mode	Inspect operability of the battery; ensure there is no overload at 24V output. If the unit has proceeded to the Device Failure mode once more sent it to the manufacturer
8) After applying power to the S2000-ASPT the indicator TEST pulses; the internal sounder is silent	The S2000-ASPT was not tested completely during manufacture	Send the unit to the manufacturer
9) The S2000-ASPT doesn't display trouble messages of a S2000-KPB unit. The connected S2000-KPB doesn't start when the fixed fire extinguishing system has been activated	The address of the S2000-KPB is not written in the S2000-ASPT configuration	Edit the configuration of the S2000-ASPT specifying the address of the connected S2000-KPB. Switch the power of the S2000-ASPT off and on again

**Table 12.1 (Continued)**

<p>10) The S2000-ASPT has not been found by the network controller</p>	<ol style="list-style-type: none"> <li>1. The interface line RS-485-1 is inoperable.</li> <li>2. Interface lines A1 and B1 are interchanged.</li> <li>3. The jumpers connecting termination resistors are set improperly.</li> <li>4. Several devices in the interface line RS-485-1 have the same network address</li> </ol>	<ol style="list-style-type: none"> <li>1. Find out and repair the failure.</li> <li>2. Find out and repair the failure.</li> <li>3. Make sure the termination resistors are connected (the jumpers are closed) at the first and the last devices in the line.</li> <li>4. Network addresses must be unique. Change the network addresses</li> </ol>
<p>11) The S2000-ASPT has not found the connected S2000-KPB units. The indicator S2000-KPB pulses and the internal sounder beeps</p>	<ol style="list-style-type: none"> <li>1. The interface line RS-485-2 is inoperable.</li> <li>2. Interface lines A2 and B2 are interchanged.</li> <li>3. The jumpers connecting termination resistors are set improperly.</li> <li>4. Several S2000-KPB units are assigned to the same network address</li> </ol>	<ol style="list-style-type: none"> <li>1. Find out and repair the failure.</li> <li>2. Find out and repair the failure.</li> <li>3. Make sure the termination resistors are connected (the jumpers are closed) at the first and the last devices in the line.</li> <li>4. Network addresses must be unique. Change the network addresses</li> </ol>

### 13 Maintenance

13.1 Operational and technical personnel responsible for maintenance of the unit must know the design and operation rules of the unit.

13.2 Information about routine maintenance works and their results should be recorded in the log of routine maintenance and monitoring of technical condition of fire alarm equipment.

13.3 Observance of periodicity, technological sequence and methods of performing routine maintenance is mandatory.

13.4 While carrying out maintenance works follow the instructions in Section “Safety Precautions” of this Manual and your duty regulations.

### 14 Storage

14.1 The unit in the consumer packing must be stored as required by Russian Standard ГOCT 15150-69.

14.2 There must not be any acid fumes, alkaline fumes and other aggressive gases and harmful impurities which can cause corrosion in the premises where the S2000-ASPT is stored.

### 15 Transportation

15.1 Packaged S2000-ASPT units must be transported by any kind of transport in covered vehicles.

15.2 The conditions for transportation of S2000-ASPT units must comply with storage conditions according to Clause 5 of Russian Standard ГOCT 15150-69.

15.3 A packaged S2000-ASPT withstands under transportation:

- Transport shaking with acceleration up to 30 m/s<sup>2</sup> with a beat frequency of 80 to 120 per minute or 15,000 beats with the same acceleration;
- Vibration in the frequency range from 10 to 55 Hz with an amplitude of displacement up to 0.35 mm;
- Ambient temperatures from minus 50°C to +50°C;
- Relative humidity up to 95% at 40°C.

15.4 After transportation at low temperatures or high humidity an S2000-ASPT must be kept unpacked for at least 24 hours in a room with normal climatic conditions immediately before putting it into operation.

## 16 Certificates

17.1 Conformity Certificate C-RU.ЧC13.B.00291 certifies that S2000-ASPT Fire Alarm and Extinguishing Control Unit meets the requirements of Federal Law of the Russian Federation of July 22, 2008 No.123-FZ.



17.2 S2000-ASPT Fire Alarm and Extinguishing Control Unit is part of Orion Addressable Fire Alarm System which is approved by Conformity Certificate No. BY/112 02.01.033 00573, issued by Republican Centre for Certification and Expertise of Licensable Activities Of Ministry for Emergency Situations of the Republic of Belarus, 73a Zakharova Str., Minsk, 220088.



17.3 Conformity Certificate No. BY/112 02.01.033 00336 certifies that the S2000-ASPT Fire Alarm and Extinguishing Control Unit meets the requirements of TR 2009/03/BY and is issued by Republican Centre for Certification and Expertise of Licensable Activities Of Ministry for Emergency Situations of the Republic of Belarus, 73a Zakharova Str., Minsk, 220088



17.4 Conformity Declaration TC № RU Д-RU.ME61.B.00319 certifies that the S2000-ASPT Fire Alarm and Extinguishing Control Unit meets the requirements of Technical Reglament of Custom Union TR CU 004/2011, TR CU 020/2011



17.5 Conformity Certificate No. POCC RU.ИК32.K00153

**ИСО 9001**



ZAO NVP Bolid, 4 Pionerskaya Str., Korolev 141070, Moscow Region, Russia

Phone/fax: +7 495 775-7155

Email: [info@bolid.ru](mailto:info@bolid.ru)

Technical Support: [support@bolid.ru](mailto:support@bolid.ru)

<http://bolid.ru>

## Appendix A

### Design of the S2000-ASPT

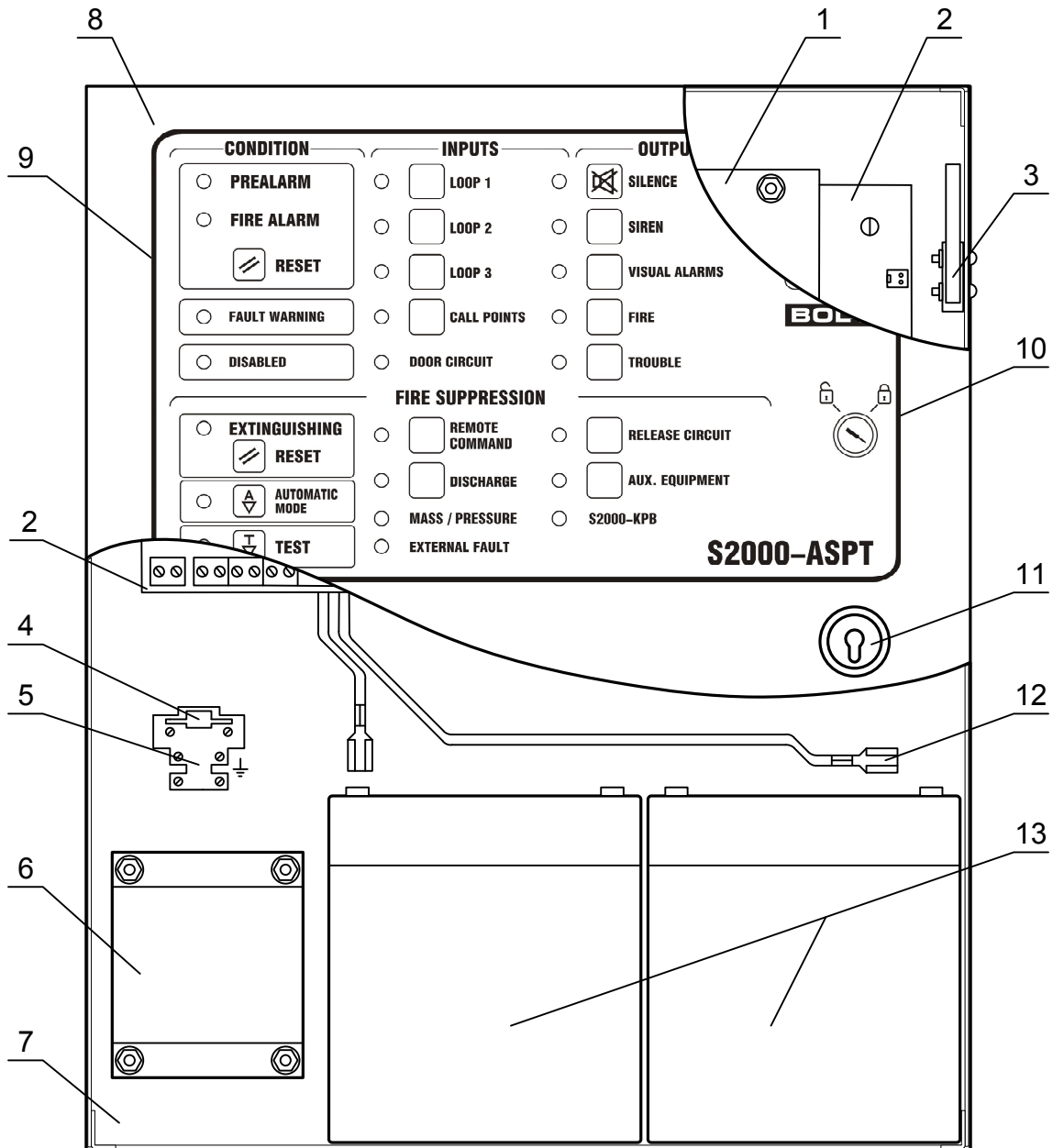

- 1 – Control board
- 2 – Main PCB
- 3 – Tamper switch
- 4 – F1 fuse holder
- 5 – Power and earth terminals
- 6 – Transformer
- 7 – Cabinet
- 8 – Cabinet's door
- 9 – Faceplate
- 10 – Key switch
- 11 – Mechanical lock
- 12 – Battery leads
- 13 – Backup batteries in assembly

# Appendix A

(Continued)

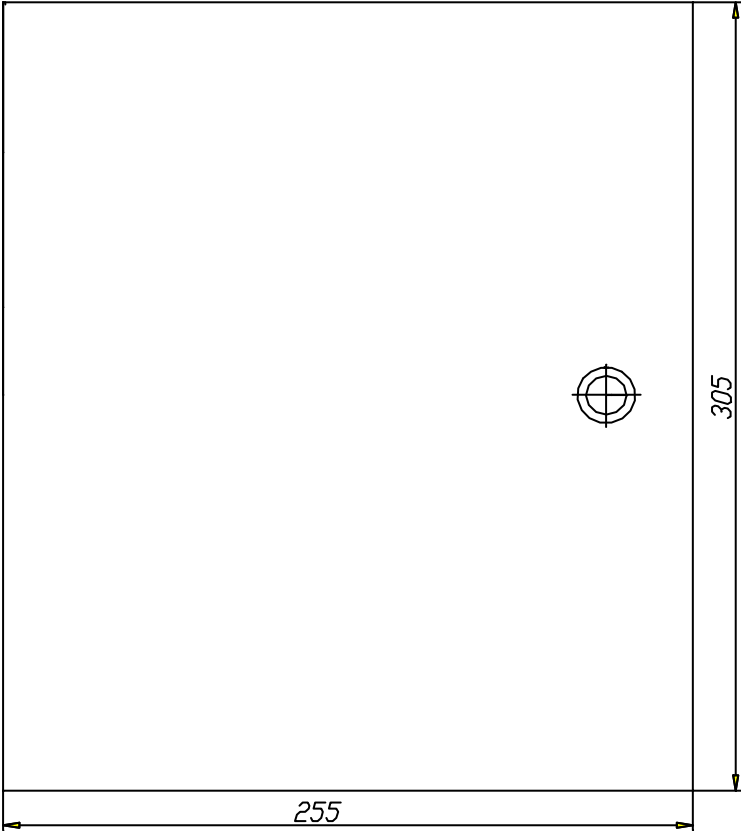

Mounting Dimensions

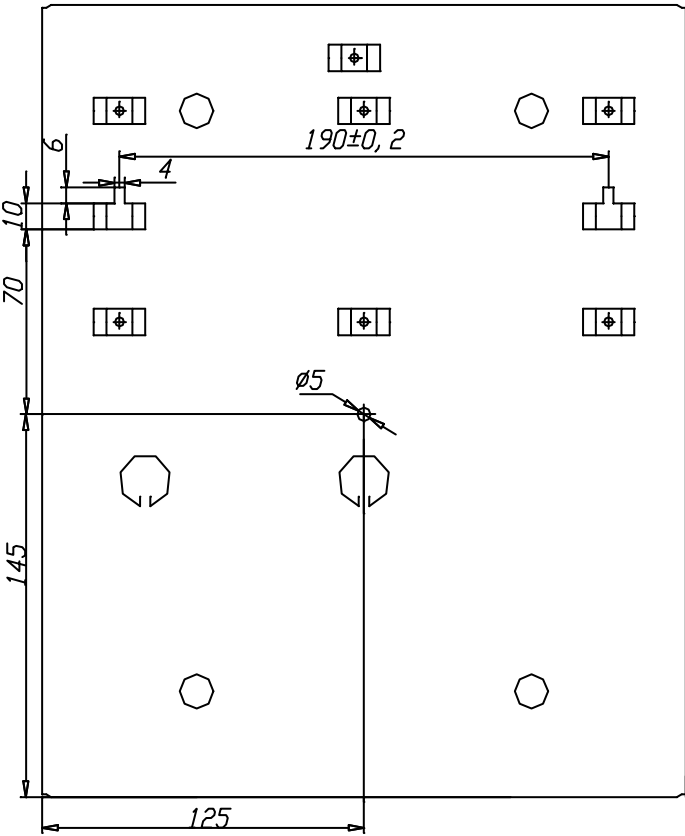

# Appendix B

## S2000-ASPT Connection Diagram

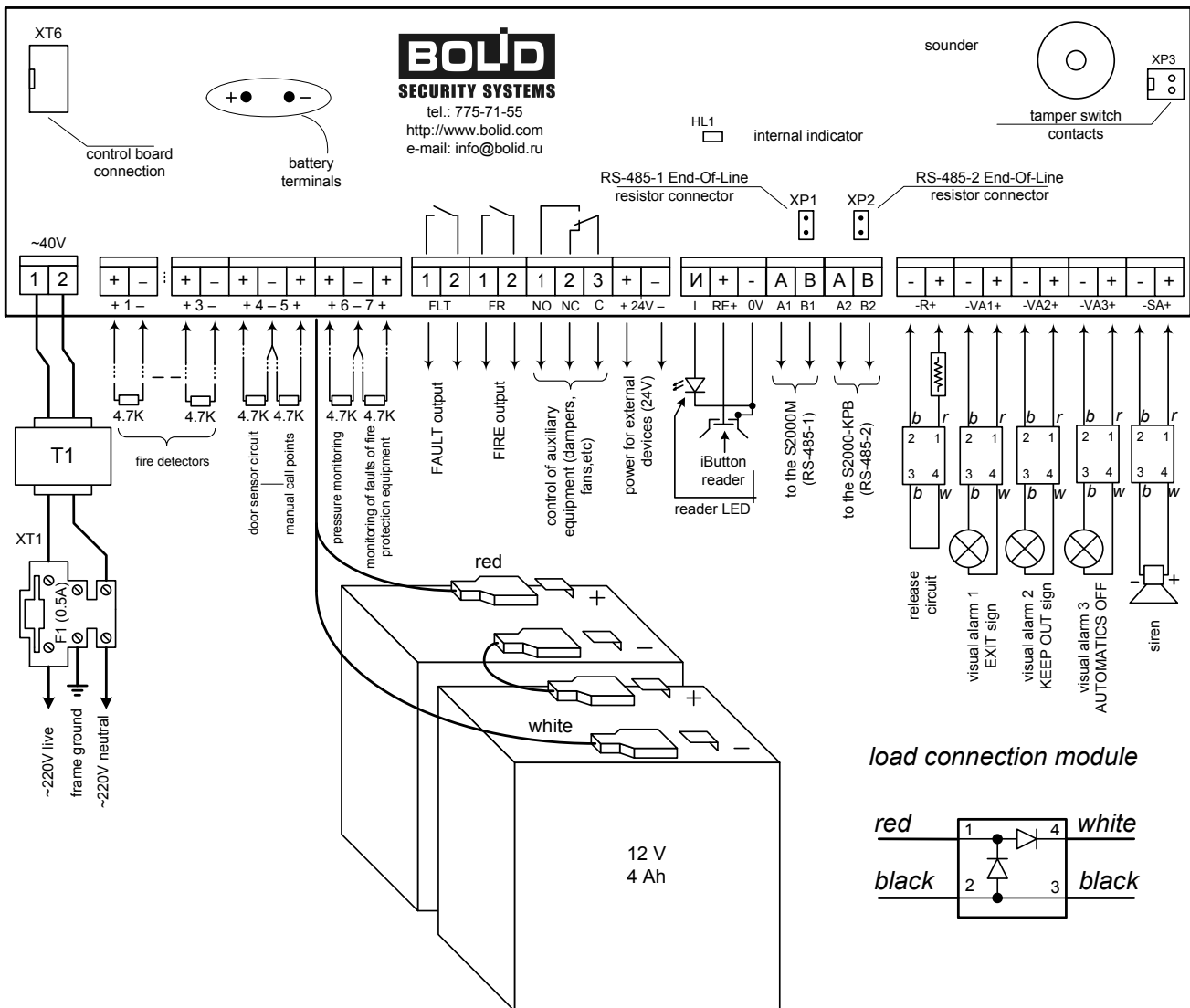

### WARNING

**IT IS FORBIDDEN TO EXPLOIT THE S2000-ASPT WITH NO BATTERIES CONNECTED SWITCH THE MAINS POWER OFF AND PULL THE FUSE F1 OUT PRIOR TO INSTALLING OR REPLACING THE BATTERIES.**

### How to start the unit:

Connect the ground wire to the ground terminal. Then connect the backup batteries interconnected with the connector provided by coupling red unit wire to the "+" terminal and the white one to the "-" terminal. Finally put the fuse F1 into the holder.

### How to shut the unit down:

Remove the fuse F1 from the holder on the S2000-ASPT PCB. Then disconnect the batteries. Finally cut the mains power out de-energizing the unit.

## Appendix C

### Schematics for Wiring Detectors into Alarm Loops

#### Type 1 (Smoke Two Threshold Alarm Loop)

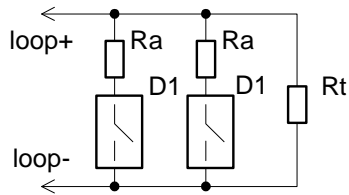

**Ra:** An additional resistance of  $1.5 \div 3 \text{ k}\Omega$ ;  
**Rt:**  $4.7 \text{ k}\Omega$ ;  
**D1:** A smoke detector

#### Type 2 (Combined Fire Alarm Loop)

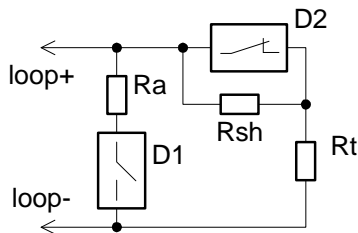

**D1:** A smoke detector;  
**D2:** A heat detector;  
**Ra:**  $0 \div 512 \Omega$ ;  
**Rsh:**  $8.2 \text{ k}\Omega$ ;  
**Rt:**  $4.7 \text{ k}\Omega$

#### Circuits of the door position sensor, the pressure detector, the manual release stations, fire equipment faults

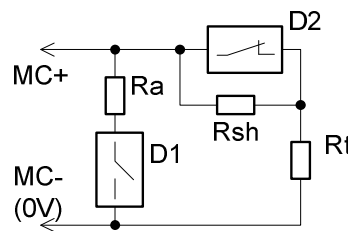

**D1:** A normally open detector;  
**D2:** A normally closed detector;  
**Ra:** An additional resistor  $510 \Omega$ ;  
**Rsh:** A shunt resistor  $8.2 \text{ k}\Omega$ ;  
**Rt:** A termination resistor  $4.7 \text{ k}\Omega$ ;  
**MC:** A monitored circuit

#### Type 3 (Heat Two Threshold Alarm Loop)

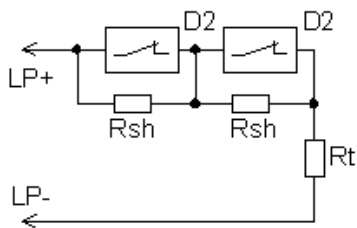

**D2:** A heat fire detector;  
**Rsh:** A shunt  $4.7 \text{ k}\Omega$  resistor;  
**Rt:** A termination resistor  $4.7 \text{ k}\Omega \pm 5\%$   $1/2 \text{ W}$



# Appendix C

(Continued)

## Connecting Smoke Detectors into Alarm Loops of Type 1

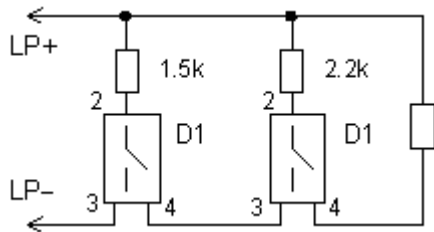

D1: A smoke fire detector

## Connecting Smoke and Heat Detectors into Alarm Loops of Type 2

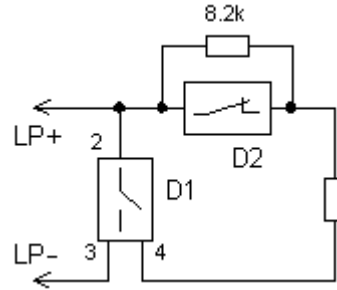

## Including Heat Detectors into Alarm Loops of Type 3

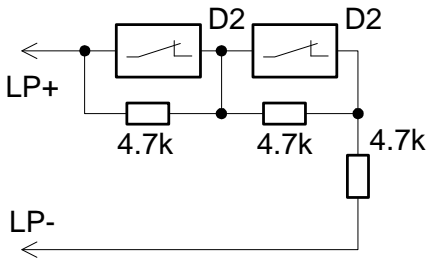

D2: A heat fire detector

## Connecting IPR 513-3 Manual Call Points

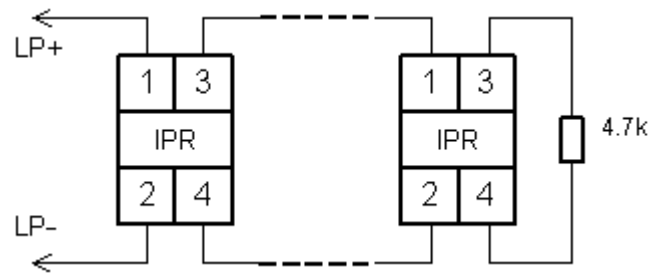

## Connecting Several Notification Appliances to the Same Output of the S2000-ASPT

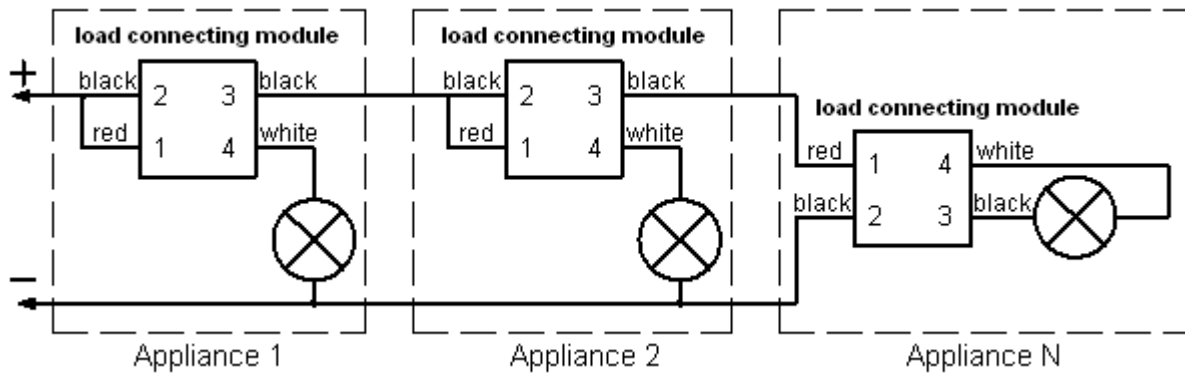

## Appendix D

### Connecting Devices for Operation in a Fixed Fire Extinguishing System

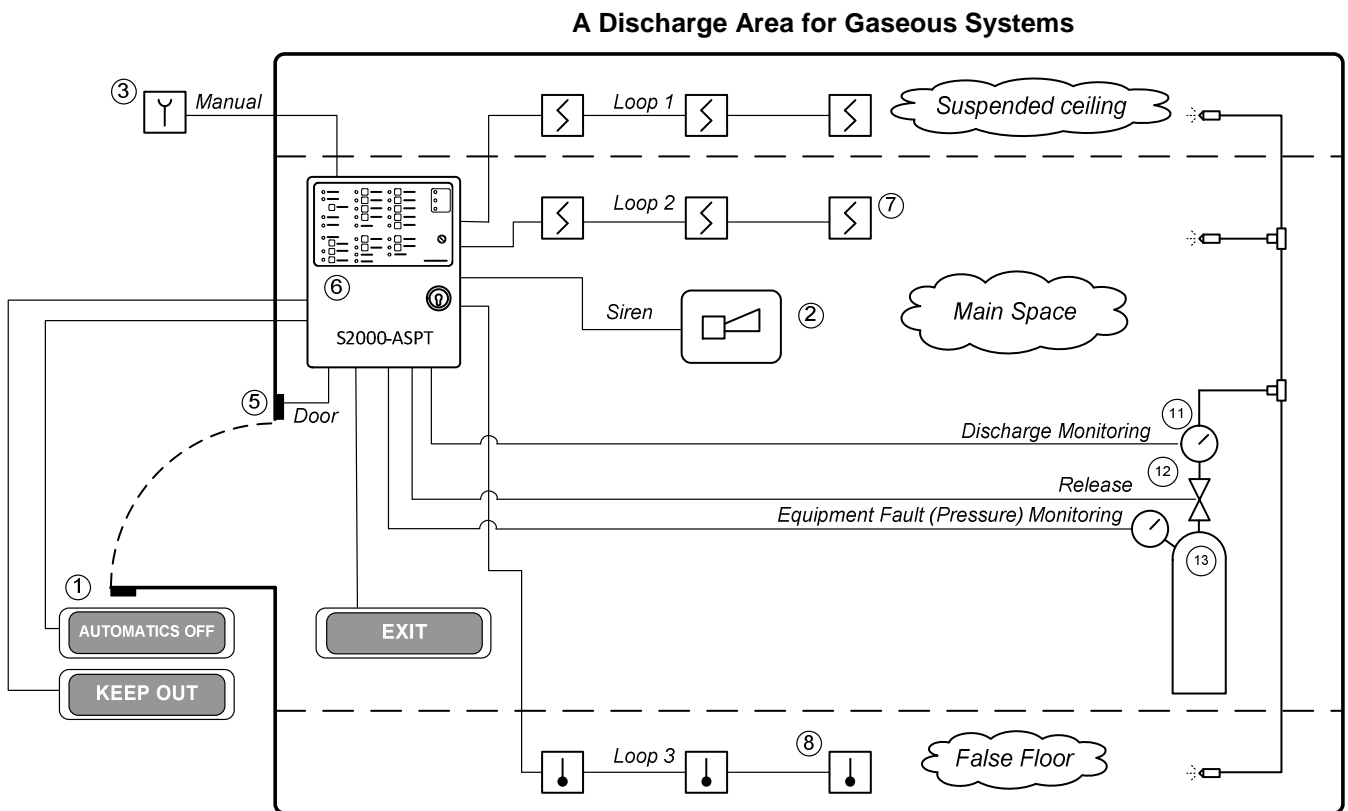
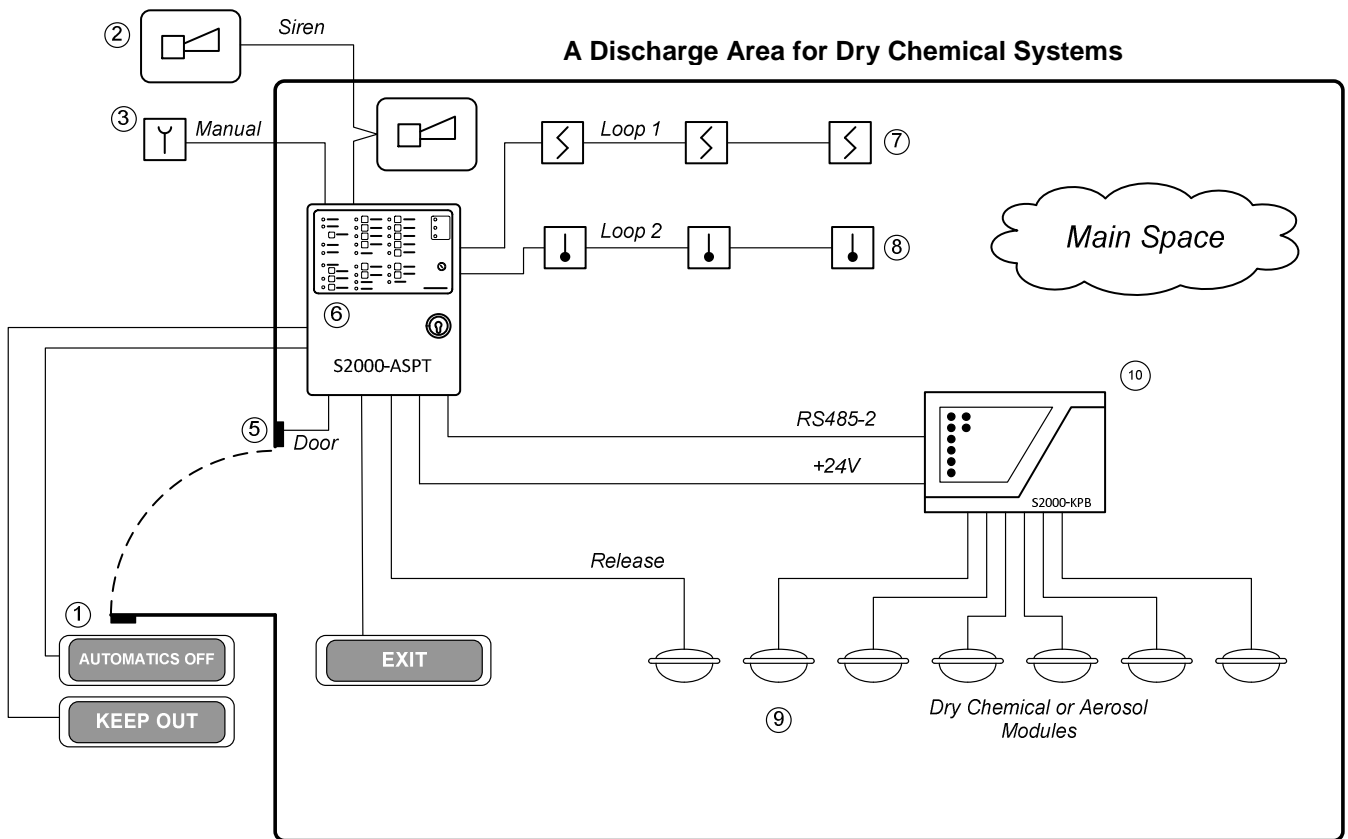

- 1: Light Alarms (Caution Signs)
- 2: Audible Alarm
- 3: Manual Release Station
- 5: Door Contact
- 6: S2000-ASPT Unit;

- 7: Smoke Detectors in Alarm Loops
- 8: Heat Detectors in Alarm Loops
- 9: Dry Chemical or Aerosol Modules
- 10: S2000-KPB Unit

- 11: Output Pressure Detector
- 12: Activator
- 13: Internal Pressure Detector

# Appendix D

(Continued)

## A Centralized Dry Chemical Fire Extinguishing System

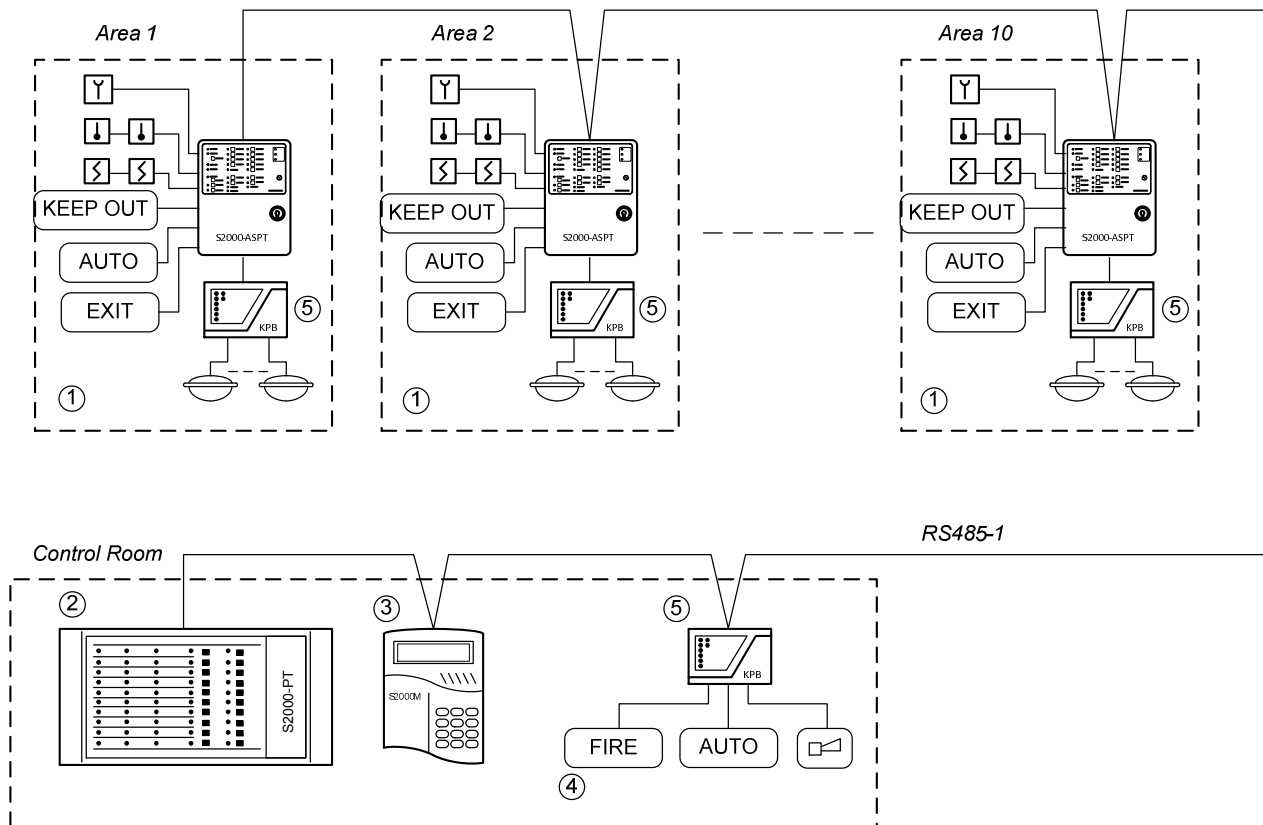

## A Centralized Gaseous Fire Extinguishing System

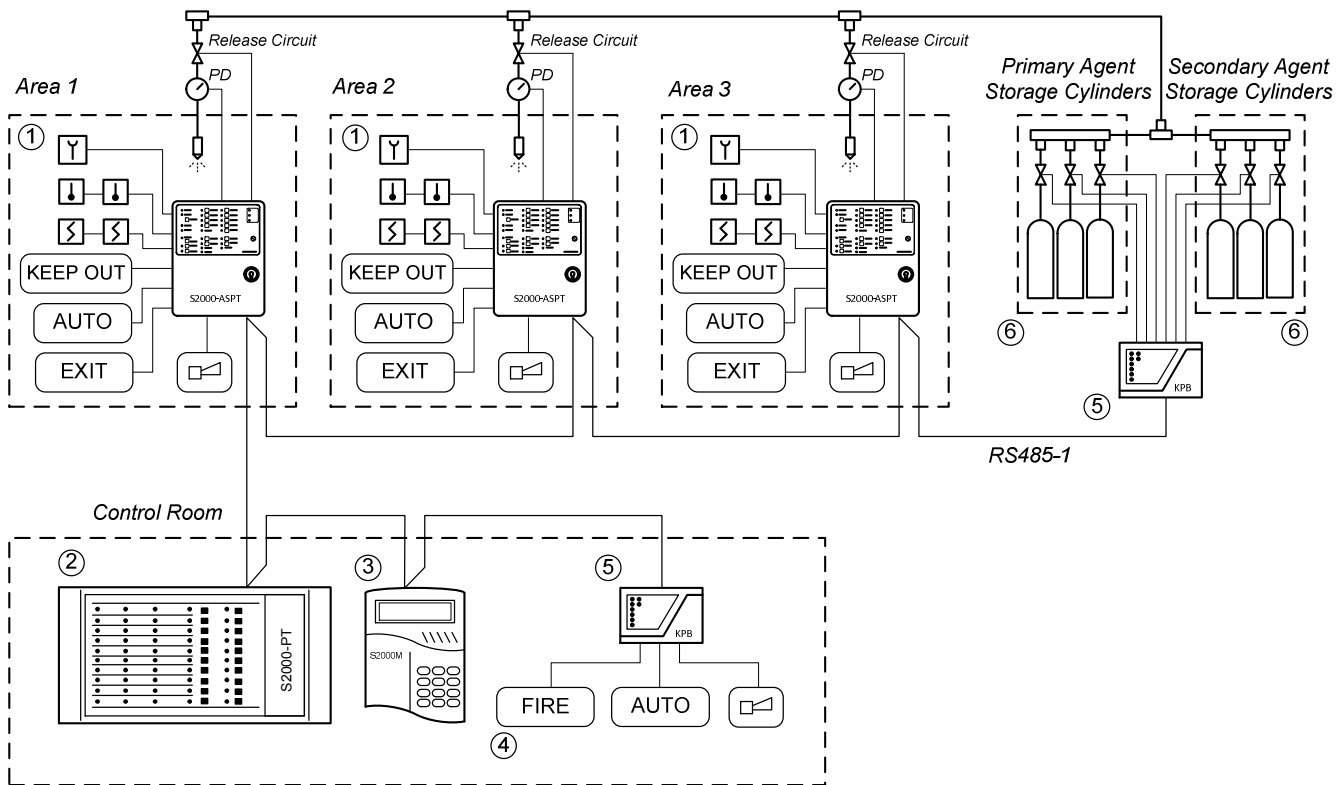

- 1: Discharge Area
- 2: S2000-PT Module;
- 3: S2000M Panel
- 4: Light and Sound Alarms
- 5: S2000-KPB Unit
- 6: Gas Installation



## Appendix F

### *Calculating the Battery Operation Time*

To meet the requirements of Clause 7.2.2.1 of Russian Standard ГOCT P 53325-2009 and Clause 15.3 of Russian Codes CII5.13130.2009, the capacity of a backup power supply should be a value which provides supplying power to the unit for 24 hours in quiescent mode and 3 hours in Fire Alarm mode.

The S2000-ASPT is designed to operate with a battery of rated voltage 24 V. The operation time of the battery in backup power mode is defined by the capacity of the battery and by a total load current consumed by the outputs VA1, VA2, VA3, SA and 24V output:

$$T_{op} = \frac{W}{I_l^\Sigma}, [\text{Hr}], \quad \text{where:}$$

$T_{op}$  : the battery operation time in hours

$W$  : the battery capacity in ampere-hours

$I_l^\Sigma$  : the total load current in amperes

$$I_l^\Sigma = I_l^{VA1} + I_l^{VA2} + I_l^{VA3} + I_l^{SA} + I_l^{24V}, [\text{A}]$$

The relationship between the  $I_l^\Sigma$  current and the battery supplying current  $I_{bat}$  in the 0...0.5 A range can be considered as linear:

$$I_{bat} = I_l^\Sigma + 0.06, [\text{A}]$$

The panel provides housing of two assembled batteries 12 V, 4.5 Ah each within the panel enclosure.

#### 1) *Evaluating of maximum $I_l^\Sigma$ for 24 hours of operation in quiescent mode*

Taking into account 25% reserved battery capacity, the average current delivered by a battery during backup supplying can be evaluated as

$$I_{backup} = 0.75 \times \frac{W}{24}, [\text{A}]$$

The current consumed from the battery,  $I_{bat}$  must not exceed the average current  $I_{backup}$ , so

$$I_l^\Sigma < 0.75 \times \frac{W}{24} - 0.06, [\text{A}]$$

Since all visual and sound alarms except for the VA3 are disabled in the Quiescent mode and don't consume current, therefore:

$$I_l^\Sigma = I_l^{VA3} + I_l^{24V}, [\text{A}] \quad (1)$$

##### 1.1) *For a battery of 4.5 Ah:*

$$I_{backup} = 0.14 [\text{A}], \quad I_l^\Sigma < 0.08 [\text{A}] \quad (2)$$

Thus, if there are no external devices connected to the 24V output of the S2000-ASPT, then the **backup power supply supplies power during 24 hours provided that a visual alarm connected to the VA3 output consumes no more than 80 mA.**

#### 2) *Evaluating maximum $I_l^\Sigma$ for 3 hours of operating in the Fire Alarm mode.*

Taking into account 25% reserved battery capacity the average current delivered by a battery during backup supplying can be evaluated as:

$$I_{backup} = 0.75 \cdot \frac{W}{3}, [\text{A}]; \quad I_l^\Sigma < 0.75 \times W / 3 - 0.06, [\text{A}]$$

Since visual alarms VA1 and VA2 are turned on in pulse mode and can be turned on simultaneously only in the No Pulse Release mode, so the maximum value can be evaluated as:

$$I_l^\Sigma = 0.5 \cdot I_l^{VA1} + 0.5 \cdot I_l^{VA2} + I_l^{VA3} + 0.75 \cdot I_l^{SA} + I_l^{24V}, [\text{A}] \quad (3)$$

##### 2.1) *For a battery of 4.5 Ah capacity we obtain that:*

$$I_{backup} = 1.125 [\text{A}], \quad I_l^\Sigma < 1.065 [\text{A}] \quad (4)$$

The values  $I_l^{VA1}$ ,  $I_l^{VA2}$ ,  $I_l^{VA3}$ ,  $I_l^{SA}$ ,  $I_l^{24V}$  must comply with  $I_l^\Sigma$  conditions and are defined depending on the types of specific alarms.

**The procedure of calculation is as follows:**

1. Based on the technical specifications for visual and sound alarms being in use, find the values of current  $I_l^{VA1}$ ,  $I_l^{VA2}$ ,  $I_l^{VA3}$ ,  $I_l^{SA}$ .
2. Based on the S2000-ASPT operation wiring diagram calculate the  $I_l^{24V}$ .
3. Calculate the  $I_l^\Sigma$  value based on the formula (1) and the conditions (2) for the quiescent mode.
4. Calculate the  $I_l^\Sigma$  value based on the formula (3) and the conditions (4) for the Fire Alarm mode.

## Appendix G

### *Personnel Action Plan in Case of Activation of the Fixed Fire Extinguishing System*

To prevent secondary actuation of the fixed fire extinguishing system during system discharge, the following sequence of operations is recommended:

1) Visually inspect the protected premises. Try to find the reason of actuation of the fire extinguishing system: whether it was a fire or smoke or a manual release station was activated. Take the necessary measures to protect people and material values against fire and effects of the extinguishing agent.

2) If the fire has been suppressed or activation has happened to be false then silence the S2000-ASPT by pushing the SILENCE button.

3) Inspect performance of the indicators on the unit faceplate: fire alarm indicators (PREALARM, FIRE ALARM), conditions of automatic mode (AUTOMATIC MODE), extinguishing mode (EXTINGUISHING). Detect the areas which are in fire.

4) Inspect performance of the light indicators of responded detectors (if applicable); check the protective elements of the manual release stations.

5) Abort Extinguishing mode and Fire Alarm mode of the unit by pushing the relevant RESET buttons.

6) De-energize the S2000-ASPT by disconnecting its mains power and backup batteries. De-energize the S2000-KPB units (if applicable).

7) Register your activity and observations into the log.

8) After investigation of the reasons of system actuation has been completed and before applying power to the S2000-ASPT, separate automatic fire suppression modules from the release circuits of the S2000-ASPT and S2000-KPB (if available) and replace them by simulators. Use a fuse with actuating current equal to automatic module's one as a simulator.

9) Carry out the pre-commissioning routines to check the S2000-ASPT operability.

10) Make sure the unit is not in an alarm mode and disable the mains and backup power supplies. Replace the simulators by the effective fire-extinguishing modules and restore the power.